

Model 6517B Electrometer

User's Manual

6517B-900-01 Rev. A / June 2008

WARRANTY

Keithley Instruments, Inc. warrants this product to be free from defects in material and workmanship for a period of one (1) year from date of shipment.

Keithley Instruments, Inc. warrants the following items for 90 days from the date of shipment: probes, cables, software, rechargeable batteries, diskettes, and documentation.

During the warranty period, Keithley Instruments will, at its option, either repair or replace any product that proves to be defective.

To exercise this warranty, write or call your local Keithley Instruments representative, or contact Keithley Instruments headquarters in Cleveland, Ohio. You will be given prompt assistance and return instructions. Send the product, transportation prepaid, to the indicated service facility. Repairs will be made and the product returned, transportation prepaid. Repaired or replaced products are warranted for the balance of the original warranty period, or at least 90 days.

LIMITATION OF WARRANTY

This warranty does not apply to defects resulting from product modification without Keithley Instruments' express written consent, or misuse of any product or part. This warranty also does not apply to fuses, software, non-rechargeable batteries, damage from battery leakage, or problems arising from normal wear or failure to follow instructions.

THIS WARRANTY IS IN LIEU OF ALL OTHER WARRANTIES, EXPRESSED OR IMPLIED, INCLUDING ANY IMPLIED WARRANTY OF MERCHANTABILITY OR FITNESS FOR A PARTICULAR USE. THE REMEDIES PROVIDED HEREIN ARE BUYER'S SOLE AND EXCLUSIVE REMEDIES.

NEITHER KEITHLEY INSTRUMENTS, INC. NOR ANY OF ITS EMPLOYEES SHALL BE LIABLE FOR ANY DIRECT, INDIRECT, SPECIAL, INCIDENTAL, OR CONSEQUENTIAL DAMAGES ARISING OUT OF THE USE OF ITS INSTRUMENTS AND SOFTWARE, EVEN IF KEITHLEY INSTRUMENTS, INC. HAS BEEN ADVISED IN ADVANCE OF THE POSSIBILITY OF SUCH DAMAGES. SUCH EXCLUDED DAMAGES SHALL INCLUDE, BUT ARE NOT LIMITED TO: COST OF REMOVAL AND INSTALLATION, LOSSES SUSTAINED AS THE RESULT OF INJURY TO ANY PERSON, OR DAMAGE TO PROPERTY.

KEITHLEY

A G R E A T E R M E A S U R E O F C O N F I D E N C E

Keithley Instruments, Inc.

Corporate Headquarters • 28775 Aurora Road • Cleveland, Ohio 44139
440-248-0400 • Fax: 440-248-6168 • 1-888-KEITHLEY (1-888-534-8453) • www.keithley.com

Model 6517B Electrometer User's Manual

©2008, Keithley Instruments, Inc.
All rights reserved.
Cleveland, Ohio, U.S.A.

Document Number: 6517B-900-01 Rev. A / Jun 2008

Any unauthorized reproduction, photocopy, or use the information herein, in whole or in part, without the prior written approval of Keithley Instruments, Inc. is strictly prohibited.

TSP, TSP-Link, and TSP-Net are trademarks of Keithley Instruments, Inc.
All Keithley Instruments product names are trademarks or registered trademarks of Keithley Instruments, Inc.
Other brand names are trademarks or registered trademarks of their respective holders.

The following safety precautions should be observed before using this product and any associated instrumentation. Although some instruments and accessories would normally be used with non-hazardous voltages, there are situations where hazardous conditions may be present.

This product is intended for use by qualified personnel who recognize shock hazards and are familiar with the safety precautions required to avoid possible injury. Read and follow all installation, operation, and maintenance information carefully before using the product. Refer to the user documentation for complete product specifications.

If the product is used in a manner not specified, the protection provided by the product warranty may be impaired.

The types of product users are:

Responsible body is the individual or group responsible for the use and maintenance of equipment, for ensuring that the equipment is operated within its specifications and operating limits, and for ensuring that operators are adequately trained.

Operators use the product for its intended function. They must be trained in electrical safety procedures and proper use of the instrument. They must be protected from electric shock and contact with hazardous live circuits.

Maintenance personnel perform routine procedures on the product to keep it operating properly, for example, setting the line voltage or replacing consumable materials. Maintenance procedures are described in the user documentation. The procedures explicitly state if the operator may perform them. Otherwise, they should be performed only by service personnel.

Service personnel are trained to work on live circuits, perform safe installations, and repair products. Only properly trained service personnel may perform installation and service procedures.

Keithley Instruments products are designed for use with electrical signals that are rated Measurement Category I and Measurement Category II, as described in the International Electrotechnical Commission (IEC) Standard IEC 60664. Most measurement, control, and data I/O signals are Measurement Category I and must not be directly connected to mains voltage or to voltage sources with high transient over-voltages. Measurement Category II connections require protection for high transient over-voltages often associated with local AC mains connections. Assume all measurement, control, and data I/O connections are for connection to Category I sources unless otherwise marked or described in the user documentation.

Exercise extreme caution when a shock hazard is present. Lethal voltage may be present on cable connector jacks or test fixtures. The American National Standards Institute (ANSI) states that a shock hazard exists when voltage levels greater than 30V RMS, 42.4V peak, or 60VDC are present. A good safety practice is to expect that hazardous voltage is present in any unknown circuit before measuring.

Operators of this product must be protected from electric shock at all times. The responsible body must ensure that operators are prevented access and/or insulated from every connection point. In some cases, connections must be exposed to potential human contact. Product operators in these circumstances must be trained to protect themselves from the risk of electric shock. If the circuit is capable of operating at or above 1000V, no conductive part of the circuit may be exposed.

Do not connect switching cards directly to unlimited power circuits. They are intended to be used with impedance-limited sources. NEVER connect switching cards directly to AC mains. When connecting sources to switching cards, install protective devices to limit fault current and voltage to the card.

Before operating an instrument, ensure that the line cord is connected to a properly-grounded power receptacle. Inspect the connecting cables, test leads, and jumpers for possible wear, cracks, or breaks before each use.

When installing equipment where access to the main power cord is restricted, such as rack mounting, a separate main input power disconnect device must be provided in close proximity to the equipment and within easy reach of the operator.

For maximum safety, do not touch the product, test cables, or any other instruments while power is applied to the circuit under test. ALWAYS remove power from the entire test system and discharge any capacitors before: connecting or disconnecting cables or jumpers, installing or removing switching cards, or making internal changes, such as installing or removing jumpers.

Do not touch any object that could provide a current path to the common side of the circuit under test or power line (earth) ground. Always make measurements with dry hands while standing on a dry, insulated surface capable of withstanding the voltage being measured.

The instrument and accessories must be used in accordance with its specifications and operating instructions, or the safety of the equipment may be impaired.

Do not exceed the maximum signal levels of the instruments and accessories, as defined in the specifications and operating information, and as shown on the instrument or test fixture panels, or switching card.

When fuses are used in a product, replace with the same type and rating for continued protection against fire hazard.

Chassis connections must only be used as shield connections for measuring circuits, NOT as safety earth ground connections.

If you are using a test fixture, keep the lid closed while power is applied to the device under test. Safe operation requires the use of a lid interlock.

If a  screw is present, connect it to safety earth ground using the wire recommended in the user documentation.

The  symbol on an instrument indicates that the user should refer to the operating instructions located in the user documentation.

The  symbol on an instrument shows that it can source or measure 1000V or more, including the combined effect of normal and common mode voltages. Use standard safety precautions to avoid personal contact with these voltages.

The  symbol on an instrument shows that the surface may be hot. Avoid personal contact to prevent burns.

The  symbol indicates a connection terminal to the equipment frame.

If this  symbol is on a product, it indicates that mercury is present in the display lamp. Please note that the lamp must be properly disposed of according to federal, state, and local laws.

The **WARNING** heading in the user documentation explains dangers that might result in personal injury or death. Always read the associated information very carefully before performing the indicated procedure.

The **CAUTION** heading in the user documentation explains hazards that could damage the instrument. Such damage may invalidate the warranty.

Instrumentation and accessories shall not be connected to humans.

Before performing any maintenance, disconnect the line cord and all test cables.

To maintain protection from electric shock and fire, replacement components in mains circuits - including the power transformer, test leads, and input jacks - must be purchased from Keithley Instruments. Standard fuses with applicable national safety approvals may be used if the rating and type are the same. Other components that are not safety-related may be purchased from other suppliers as long as they are equivalent to the original component (note that selected parts should be purchased only through Keithley Instruments to maintain accuracy and functionality of the product). If you are unsure about the applicability of a replacement component, call a Keithley Instruments office for information.

To clean an instrument, use a damp cloth or mild, water-based cleaner. Clean the exterior of the instrument only. Do not apply cleaner directly to the instrument or allow liquids to enter or spill on the instrument. Products that consist of a circuit board with no case or chassis (e.g., a data acquisition board for installation into a computer) should never require cleaning if handled according to instructions. If the board becomes contaminated and operation is affected, the board should be returned to the factory for proper cleaning/servicing.

Table of Contents

Section	Topic	Page
1	Introduction	1-1
	Overview.....	1-2
	Capabilities and features overview.....	1-2
	Options and accessories.....	1-3
	Specifications.....	1-5
	Unpacking and inspection.....	1-5
	Inspection for damage.....	1-5
	Handling precautions.....	1-5
	Shipment contents.....	1-5
	Documentation.....	1-5
	Repacking for shipment.....	1-6
2	Getting Started	2-1
	Introduction.....	2-2
	Front and rear panel familiarization.....	2-2
	Front panel summary.....	2-2
	Rear panel summary.....	2-4
	Power-up.....	2-6
	Line power connection.....	2-6
	Power-up procedure.....	2-6
	Display.....	2-6
	Primary display line.....	2-6
	Secondary display line.....	2-7
	Bench defaults.....	2-7
	Restoring bench defaults.....	2-7
	Function default settings.....	2-7
3	Basic Measurements	3-1
	Introduction.....	3-2
	Changing functions.....	3-2
	Voltage measurements.....	3-2
	Guarding.....	3-3
	Current measurements.....	3-4
	Resistance measurements.....	3-5
	Auto V-Source.....	3-6
	Amps Rel.....	3-6
	Resistivity measurements.....	3-7
	Charge measurements.....	3-9
	Auto discharge.....	3-10
	Temperature and humidity measurements.....	3-10
	Connections.....	3-10
	Measurement control.....	3-11
	Temperature units.....	3-11
	Display reading options.....	3-12
4	Measurement Options	4-1
	Introduction.....	4-3
	Multiple displays.....	4-3
	Menus.....	4-5
	Navigating menus.....	4-6

Section	Topic	Page
	Voltage source	4-7
	Connections	4-7
	Basic operation	4-9
	Configuring V-Source	4-9
	Relative	4-9
	Configuring rel	4-10
	Zero check	4-10
	Zero correct	4-10
	Triggering	4-10
	Idle	4-11
	Control sources	4-12
	Device action	4-12
	Output trigger	4-12
	Counters	4-12
	Bench default setup	4-12
	Speed	4-13
	Configuring speed	4-13
	Resolution	4-13
	Configuring resolution	4-13
	Filter	4-13
	Filter types	4-14
	Filter modes	4-14
	Median filter	4-14
	Configuring filters	4-15
	Buffer (data store)	4-15
	Storing readings	4-15
	Math	4-16
	Selecting and configuring math	4-17
	Enabling math	4-18
	Additional math operations	4-18
	Test sequences	4-19
	Configuring test sequences	4-19
	Connections	4-20
	Running a test	4-21
	Internal scanning	4-21
	Configure internal scanner	4-21
	Perform the scan	4-21
	Close/open channels	4-22
	External scanning	4-22
	Trigger connections	4-23
	Configure external channels	4-23
	Perform the scan	4-23
5	Remote Operation	5-1
	Overview	5-2
	Software support	5-2
	LabView driver	5-2
	Remote interfaces	5-2
	IEEE-488 bus	5-2
	RS-232 interface	5-3
	Common commands	5-5
	SCPI commands	5-5
	SCPI command syntax	5-6
	SCPI signal-oriented commands	5-8
	SCPI subsystem commands	5-8
	Program examples	5-13
	Changing function and range	5-13
	One-shot triggering	5-14
	Continuous triggering #1	5-15
	Continuous triggering #2	5-15

Section	Topic	Page
	Generating SRQ on buffer full	5-16
	Storing readings in the buffer	5-17
	Taking readings with the scanner card	5-18
	Test sequence: Staircase sweep	5-19
Index	I-1

This page left blank intentionally.

List of Figures

Section	Figure	Title	Page
2	Figure 2-1	Model 6517B front panel.....	2-2
2	Figure 2-2	Model 6517B rear panel	2-4
3	Figure 3-1	Voltage measurements	3-3
3	Figure 3-2	Current measurements	3-4
3	Figure 3-3	Resistance measurements	3-6
3	Figure 3-4	Resistivity measurements.....	3-9
3	Figure 3-5	Charge measurements	3-10
3	Figure 3-6	External temperature and humidity measurements	3-11
4	Figure 4-1	Main menu display.....	4-5
4	Figure 4-2	Independent V-Source connections.....	4-8
4	Figure 4-3	FVMI connections	4-8
4	Figure 4-4	Basic trigger model (simplified).....	4-11
4	Figure 4-5	Advanced trigger model (simplified)	4-11
4	Figure 4-6	Filter response/noise window	4-14
4	Figure 4-7	Combining math calculations.....	4-18
4	Figure 4-8	Typical FVMI connections.....	4-20
4	Figure 4-9	Trigger connections using trigger link	4-23
5	Figure 5-1	IEEE-488 connections	5-3
5	Figure 5-2	Hierarchy of the example SENSE1 commands	5-6

This page left blank intentionally.

List of Tables

Section	Table	Title	Page
4	Table 4-1	Multiple displays by function	4-3
4	Table 4-2	Main menu summary	4-5
4	Table 4-3	Configuration settings for each measurement function	4-6
4	Table 4-4	Configuration settings for instrument operations	4-6
4	Table 4-5	Menu summary	4-7

This page left blank intentionally.

In this section:

Topic	Page
Overview	1-2
Capabilities and features overview	1-2
Options and accessories	1-3
Specifications	1-5
Unpacking and inspection	1-5
Inspection for damage	1-5
Handling precautions	1-5
Shipment contents	1-5
Repacking for shipment	1-6

Overview

This section contains general information about the Keithley Instruments Model 6517B Electrometer.

If you have any questions after reviewing this information, please contact your local Keithley Instruments representative or call one of our applications engineers at 1-888-KEITHLEY (1-888-534-8453) within the U.S. and Canada. You can also contact us through our website at www.keithley.com.

Capabilities and features overview

The Model 6517B is a 6½-digit electrometer/high-resistance test and measurement system with the following measurement capabilities:

- DC voltage measurements from 1 μ V to 210V.
- DC current measurements from 10aA to 21mA.
- Charge measurements from 10fC to 2.1 μ C.
- Resistance measurements from 10 Ω to 210P Ω .
- Surface resistivity measurements.
- Volume resistivity measurements.
- External temperature measurements from -25°C to 150°C using the supplied Model 6517-TP thermocouple.
- Relative humidity measurements (0 to 100%) using the optional Model 6517-RH probe.

Some additional capabilities of the Model 6517B include:

- Built-in V-Source. The 100V range provides up to \pm 100V at 10mA, while the 1000V range provides up to \pm 1000V at 1mA.
- Data storage (50,000 points).
- Single button zeroing (REL).
- Built-in math functions.
- Filtering, averaging, and median.
- Built-in test sequences.
- Remote operation using the IEEE-488 (GPIB) bus or the RS-232 interface.
- Scan (measure) channels of an external scanner.
- Scan (measure) channels of an internal scanner card (for example, Keithley Instruments Model 6521 or Model 6522) installed in the option slot.

Options and accessories

The following options and accessories are available from Keithley Instruments for use with the Model 6517B Electrometer:

NOTE Check the Keithley Instruments website (www.keithley.com) for additional options and accessories that may have been added to the Keithley Instruments product line for use with the Model 6517B Electrometer.

Cables and adapters

Model 237-ALG-2 Triax Cable: This is a 2-meter (6.6ft) low-noise triax cable terminated with a 3-slot male triax connector on one end and 3 alligator clips on the other.

Model 237-BNC-TRX Adapter: This is a male BNC to 3-lug female triax adapter (guard disconnected). It is used to terminate a triax cable with a BNC plug. Suitable for use with the Model 6517B V-Source in high voltage applications.

Model 237-TRX-T Adapter: This is a 3-slot male to dual 3-lug female triax tee adapter for use with 7078-TRX triax cables. Suitable for use with the Model 6517B V-Source in high voltage applications.

Model 237-TRX-TBC Connector: This is a 3-lug female triax bulkhead connector with cap for assembly of custom panels and interface connections. Suitable for use with the Model 6517B V-Source in high voltage applications.

Model 6517B-ILC-3 Interlock Cable: This is a 3 meter (6.6 ft) cable terminated with a 4 pin Phoenix connector on one end and a 4 pin Switchcraft connector on the other end.

Model 7078-TRX-BNC Adapter: This is a 3-slot male triax to female BNC adapter. This adapter lets you connect a BNC cable to the triax input of the Model 6517B. Suitable for use with the Model 6517B in high voltage applications.

Models 7078-TRX-3, 7078-TRX-10 and 7078-TRX-20 Triax Cables: These are low noise triax cables terminated at both ends with 3-slot male triax connectors. The Model 7078-TRX-3 is 3ft (0.9m) in length, the Model 7078-TRX-10 is 10ft (3m) in length, and the Model 7078-TRX-20 is 20ft (6m) in length.

Model 7078-TRX-TBC Connector: This is a 3-lug female triax bulkhead connector with cap for assembly of custom panels and interface connections. Suitable for use with the Model 6517B V-Source in high voltage applications.

Models 7007-1 and 7007-2 Shielded IEEE-488 Cables: Connect the Model 6517B to the IEEE-488 bus using shielded cables and connectors to reduce electromagnetic interference (EMI). The Model 7007-1 is one meter long; the Model 7007-2 is two meters long.

Models 8501-1 and 8501-2 Trigger Link Cables: Connect the Model 6517B to other instruments with Trigger Link connectors (for example, Model 7001 Switch System). The Model 8501-1 is one meter long; the Model 8501-2 is two meters long.

Model 8502 Trigger Link Adapter: Allows you to connect the Trigger Link of the Model 6517B to instruments that use the standard BNC (In/Out) external triggering technique.

Model 8606 High Performance Probe Tip Kit: Consists of two spade lugs, two alligator clips, and two spring hook test probes (the spade lugs and alligator clips are rated at 30V RMS, 42.4V peak; the test probes are rated at 1000V). These components are designed to be used with high performance test leads terminated with banana plugs, such as the Model 8607 High Performance Banana Cables.

Model 8607 High Performance Banana Cables: Consists of two high voltage (1000V) banana cables. The cables are terminated with banana plugs that have retractable sheaths.

CS-751 Barrel Adapter: This is a barrel adapter that allows you to connect two triax cables together. Both ends of the adapter are terminated with 3-lug female triax connectors.

Case and rack mount kits

Model 1050 Padded Carrying Case: A carrying case for a Model 6517B. Includes handles and shoulder strap.

Model 4299-1 Single Fixed Rack Mount Kit: Mounts a single Model 6517B in a standard 19-inch rack.

Model 4299-2 Side-by-side Rack Mount Kit: Mounts two instruments side-by-side in a standard 19-inch rack.

Model 4288-4 Side-by-side Rack Mount Kit: Mounts a Model 6517B and a 5.25-inch instrument side-by-side in a standard 19-inch rack.

Probes

Model 6517-RH Humidity Probe with Cable: This sensor allows the Model 6517B to make relative humidity measurements (0 to 100%). Also included is an extension cable (part number CA-129-1).

Model 6517-TP Thermocouple with Leads: This type K thermocouple sensor allows the Model 6517B to make external temperature measurements from -190°C to 1350°C .

Scanner cards

Model 6521 Low Current Scanner Card: This 10-channel low current scanner card is terminated with BNC connectors and plugs into the option slot of the Model 6517B.

Model 6522 Low Current/Low Voltage Scanner Card: This 10-channel low current/low voltage scanner card is terminated with triax connectors and plugs into the option slot of the Model 6517B.

Test fixture

Model 8009 Resistivity Test Fixture: This is a guarded test fixture for measuring volume and surface resistivities. It can accommodate sheet samples 64 to 102mm (2-1/2 to 4 in.) in diameter and up to 3.175mm (1/8 in.) thick.

Software

Model 6524 Hi-R Software Package: Designed to aid in making more repeatable high resistance/resistivity measurements. Four windows-driven programs increase measurement precision, ease download and analysis of Hi-R data, and allow cross-correlation of environmental factors.

Specifications

Full Model 6517B specifications are included in the Model 6517B Reference Manual, Appendix A. Check the Keithley Instruments website at www.keithley.com for the latest updates to the specifications.

Unpacking and inspection

Inspection for damage

The Model 6517B was carefully inspected electrically and mechanically before shipment. After unpacking all items from the shipping carton, check for any obvious signs of physical damage that may have occurred during transit (there may be a protective film over the display lens, which can be removed). Report any damage to the shipping agent immediately. Save the original packing carton for possible future shipment. Before removing the Model 6517B from the anti-static bag, observe the following handling precautions.

Handling precautions

- Always grasp the Model 6517B by the covers.
- After removing the Model 6517B from its anti-static bag, inspect it for any obvious signs of physical damage; report any such damage to the shipping agent immediately.
- When the Model 6517B is not installed and connected, keep the unit in its anti-static bag and store it in the original packing carton.

Shipment contents

The following items are included with every Model 6517B order:

- Model 6517B Electrometer with line cord
- Protective Triax Shield/Cap (CAP-28-1)
- 237-ALG-2 Triax Cable terminated with alligator clips on one end
- Accessories as ordered
- Certificate of calibration
- CD containing complete documentation and required software

Documentation

A CD-ROM containing this User's Manual, a Reference Manual, and required software is included with each Model 6517B. Check the Keithley Instruments website at www.keithley.com for the latest versions of the manuals. The latest manuals can be downloaded (in PDF format) from the website.

Repacking for shipment

Should it become necessary to return the Model 6517B for repair, carefully pack the unit in its original packing carton or the equivalent, and follow these instructions:

- Call the repair department toll-free at 1-888-KEITHLEY (1-888-534-8453), within the U.S. and Canada, to obtain a Return Material Authorization (RMA) number.
- Advise as to the warranty status of the Model 6517B.
- Write ATTENTION REPAIR DEPARTMENT and the RMA number on the shipping label.
- Complete and include the Service Form located at the back of this manual.

In this section:

Topic	Page
Introduction	2-2
Front and rear panel familiarization.....	2-2
Front panel summary	2-2
Rear panel summary	2-4
Power-up	2-6
Line power connection	2-6
Power-up procedure	2-6
Display	2-6
Primary display line	2-6
Secondary display line	2-7
Bench defaults	2-7
Restoring bench defaults	2-7
Function default settings	2-7

Introduction

This section contains identification and descriptions of controls and components of the Keithley Instruments Model 6517B Electrometer and detailed information for powering up the Model 6517B.

Front and rear panel familiarization

Front panel summary

The front panel of the Model 6517B is shown in [Figure 2-1](#). The descriptions of the front panel controls follow [Figure 2-1](#).

Figure 2-1
Model 6517B front panel

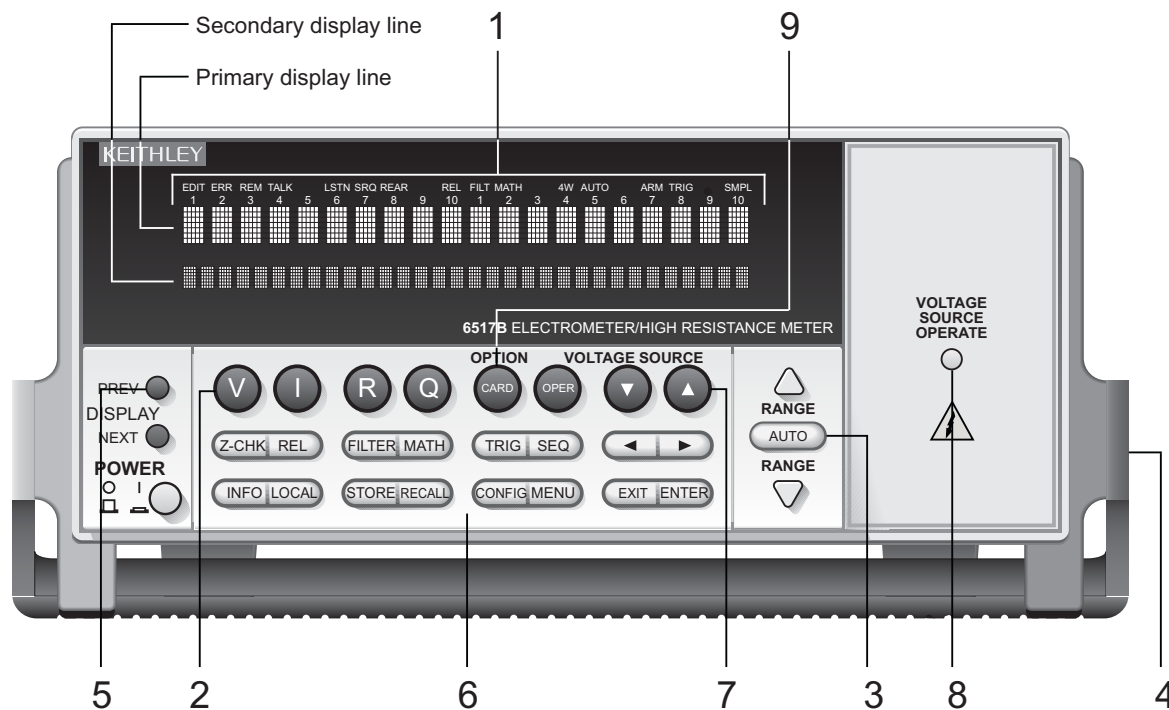

1 ANNUNCIATORS

EDIT	Editing voltage source values
ERR	Questionable reading
REM	In remote
TALK	Addressed to talk
LSTN	Addressed to listen
SRQ	Service Request
REL	Relative reading displayed
FILT	Digital filter enabled
MATH	Math calculation enabled
AUTO	Autoranging enabled
ARM	Trigger armed; not in idle
*(asterisk)	Reading being stored

2 FUNCTION KEYS

Select measurement function; volts (V), amps (I), resistivity (R) or coulombs (Q).

3 RANGE KEYS

\triangle	Moves to higher range; increments digit.
∇	Moves to lower range; decrements digit.
AUTO	Enables/disables autorange.

4 HANDLE

Pull out and rotate to desired position.

5 DISPLAY KEYS

PREV/NEXT Scroll through multiple displays of a function.

6 OPERATION KEYS

Z-CHK	Enables/disables zero check: enable zero check before changing functions.
REL	Enables/disables relative reading.
FILTER	Displays digital filter status for present function and toggles filter on/off.
MATH	Displays math calculation and toggles math on/off if configured.
TRIG	Triggers unit.
SEQ	Performs selected test sequence.
◀ and ▶	Moves cursor among data entry digits, menu selections, and information displays.
INFO	Shows context-sensitive information about the present display.
LOCAL	Cancels remote operation.
STORE	Enables data storage.
RECALL	Displays reading data (reading, number, time). Use PREV/NEXT DISPLAY for maximum, minimum average, standard deviation.
CONFIG	Configures functions and operations.
MENU	Saves/restores instrument conditions; sets up communications; performs calibration and self-tests; defines limits, digital output, and other miscellaneous operations.
EXIT	Cancels selection, moves back within menu structure.
ENTER	Holds reading, enters selection, moves down within menu structure.

7 VOLTAGE SOURCE KEYS

OPER	Toggles V-source between operate and standby.
\triangle and ∇	Adjusts V-source value.

8 VOLTAGE SOURCE OPERATE

Indicator light is on when in operation, off in standby.

9 OPTION CARD KEY

Use to program and operate an optional feature. Also use to view external scanner channels.

Rear panel summary

The rear panel of the Model 6517B is shown in [Figure 2-2](#). The descriptions of the rear panel components follow [Figure 2-2](#).

Figure 2-2
Model 6517B rear panel

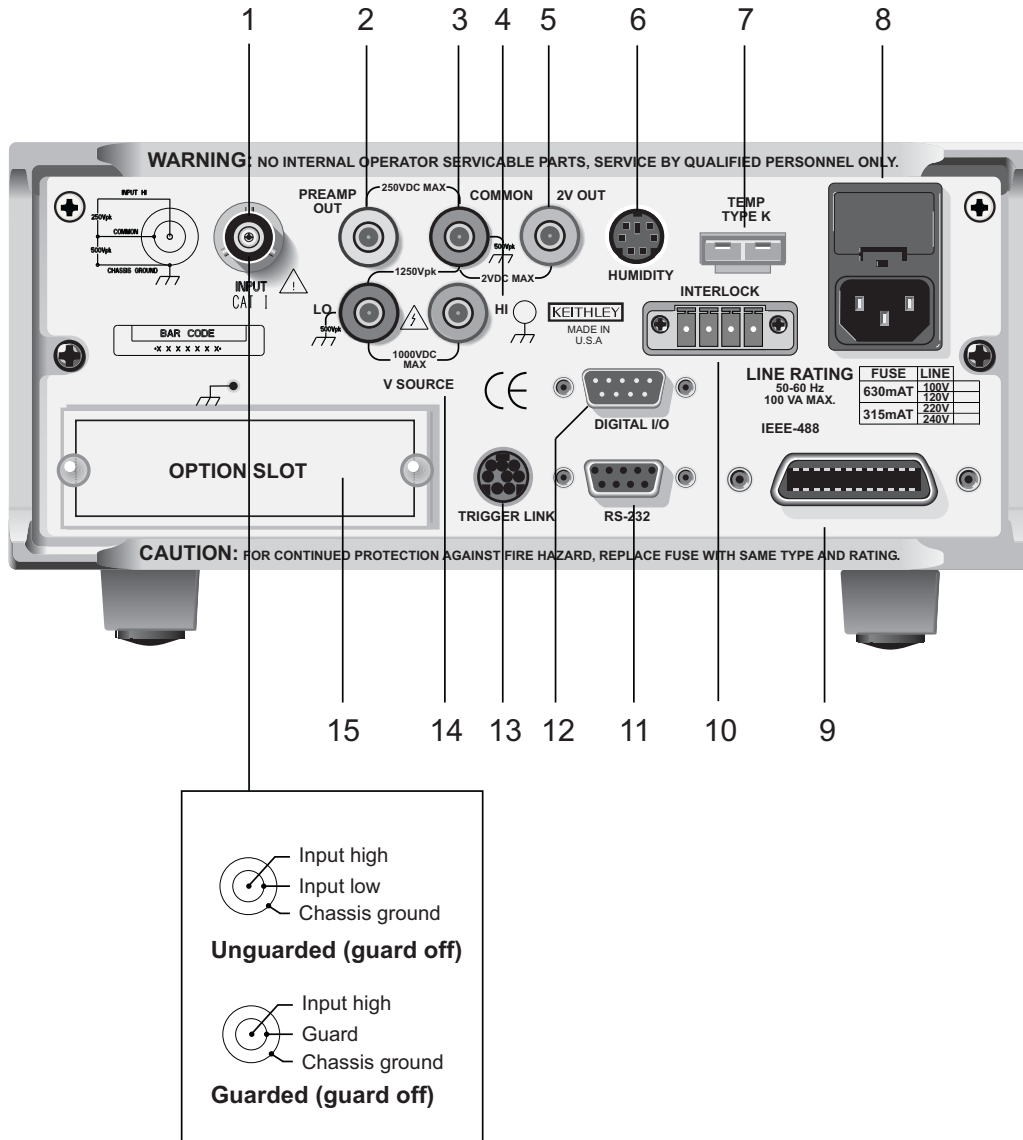

1 INPUT CONNECTOR

Unguarded Configuration	Disable GUARD for amps, ohms, coulombs and unguarded voltage measurements.
Guarded Configuration	Enable GUARD for guarded voltage measurements.

2 PREAMP OUT

Follows the signal amplitude applied to the INPUT terminal. With GUARD on, PREAMP OUT is connected to the inner shell of the INPUT triax connector to configure the input for guarded voltage measurements. Referenced to COMMON. See the Model 6517B Reference Manual for more information.

3 COMMON

Connector that is internally connected to INPUT low.

4 CHASSIS GROUND

Attached cable that connects the chassis to ground through the power line cord. COMMON can be connected to chassis ground by plugging the cable into COMMON. For floating measurements, make sure the ground cable connection between COMMON and Chassis Ground is open.

5 2V ANALOG OUTPUT

Connector provides a scaled 0 to 2V output that is referenced to COMMON. It is typically connected to a measuring device such as a chart recorder. See the Model 6517B Reference Manual for more information.

6 HUMIDITY

Connect the optional Keithley Instruments Model 6517-RH probe for relative humidity measurements.

7 TEMP TYPE K

Connect the Keithley Instruments Model 6517-TP type K thermocouple for temperature measurements.

8 POWER LINE INPUT MODULE

Provides connections for power line input and contains the line fuse. If the fuse needs to be replaced, refer to the procedure in Section 2 of the Model 6517B Reference Manual.

9 IEEE-488 CONNECTOR

Connects the Model 6517B to the IEEE-488 (GPIB) bus. Use shielded IEEE-488 cables.

10 INTERLOCK

Connects the safety interlock to a test fixture using an appropriate cable. Interlock is automatically enabled when the appropriate interlock cable is connected to the 6517B. Rated at 50-60 Hz, 140 VA max. The interlock's CS-1305 connector includes four pins (left to right as viewed from rear of the 6517B):

- Pin 1: Interlock safe
- Pin 2: Ground
- Pin 3: +5 VDC output
- Pin 4: Surface/volume select (low = volume, high = surface)

11 RS-232

DB-9 connector for the RS-232 interface. Use a standard RS-232 cable.

12 DIGITAL I/O

A male DB-9 connector for the four TTL-compatible digital output lines.

13 TRIGGER LINK

An 8-pin micro DIN connector for sending and receiving trigger pulses to and from other instruments.

14 V-SOURCE HI and LO

Safety banana jacks for the voltage source.

15 OPTION SLOT

An option card, such as the Keithley Instruments Model 6521 or Model 6522 scanner card, can be installed in this slot.

Power-up

Line power connection

Follow the procedure below to connect the Model 6517B to line power and turn on the instrument.

CAUTION Operating the instrument on an incorrect line voltage may cause damage to the instrument, possibly voiding the warranty.

1. Before plugging in the power cord, make sure that the front panel power switch is in the off (O) position. Be sure that line input voltage is set to the correct range for the power supply being used to power the Model 6517B.

NOTE Line voltage is pre-set at the factory, but may be reset in the field by adjusting the voltage selector behind the left ear. To access the voltage selector, first remove the handle then remove the left mounting ear. The current voltage setting is the marking closest to the small circle.

2. Connect the female end of the supplied power cord to the AC receptacle on the rear panel. Connect the other end of the power cord to a grounded AC outlet.

WARNING *The power cord supplied with the Model 6517B contains a separate ground wire for use with grounded outlets. When proper connections are made, instrument chassis is connected to power line ground through the ground wire in the power cord. Failure to use a grounded outlet may result in personal injury or death due to electric shock.*

Power-up procedure

1. Turn on the instrument by pressing the front panel power switch to the on (I) position.
2. During power-up, the Model 6517B performs self-tests on its memory elements. If a failure occurs, the instrument momentarily displays an error message and turns on the ERR annunciator. If the instrument passes the self-tests, the firmware revision level and bus interface information are displayed. For complete information on the power-up sequence, see Section 2 in the Model 6517B Reference Manual.

Display

As shown in the [Model 6517B front panel](#) illustration (see [Figure 2-1](#)), the front panel has three lines of display information: the primary display line, the secondary display line, and annunciators.

Primary display line

The top line displays readings along with units. It can also display measurement type, "hold," math operating type, channel number, menu headings, and messages. Status and error messages are listed in Section 2 of the Reference Manual.

Secondary display line

The bottom line displays the range, V-Source value, menu items, messages, and multiple displays (see [Section 4](#)). Longer text strings are indicated by arrows on either end of the display line. Use the cursor keys (◀ and ▶) to display the additional information.

Bench defaults

The Model 6517B can save ten user setups in non-volatile memory. You can select one of the user setups as the power-on default or have the instrument power up to either of the two factory defaults (optimized for “BENCH” or “GPIB” operation). For more information on saving and restoring user setups, see Section 2 in the Model 6517B Reference Manual.

Restoring bench defaults

Since the basic measurement procedures in this manual assume the BENCH defaults, reset the instrument from the **SAVESETUP** item of the **MAIN MENU** by performing the following steps:

1. Press the **MENU** key to display the main menu:
MAIN MENU
SAVESETUP COMMUNICATION CAL ▶ ◀ TEST LIMITS STATUS-MSG GENERAL
2. If the **SAVESETUP** option is not blinking, press the ◀ key until it is blinking and then press **ENTER** to view the setup menu:
SETUP MENU
SAVE RESTORE POWERON RESET
3. Select the **RESET** option using the cursor keys (◀ and ▶) and press **ENTER** to view the reset menu:
RESET ORIGINAL DFLTS
BENCH GPIB
4. Select the **BENCH** option using the cursor keys (◀ and ▶) and press **ENTER**. The following message is displayed:
RESETTING INSTRUMENT
 Press **ENTER** to confirm, **EXIT** to abort.
5. Press **ENTER** to confirm. The display will go to the volts function with zero check enabled and auto-range disabled.

Function default settings

Other BENCH default settings for each function include:

- Triggers: Continuous measurements
- Measurement speed (integration time): Normal, 1 power line cycle
- Digital filter: Enabled, averaging, 10 readings
- Median filter: Enabled, rank 1
- Display resolution: 5½ digits

See [Menus](#) for more information.

This page left blank intentionally.

In this section:

Topic	Page
Introduction	3-2
Changing functions	3-2
Voltage measurements.....	3-2
Guarding	3-3
Current measurements.....	3-4
Resistance measurements.....	3-6
Auto V-Source	3-6
Amps Rel.....	3-6
Resistivity measurements	3-7
Charge measurements.....	3-9
Auto discharge	3-10
Temperature and humidity measurements.....	3-10
Connections	3-10
Measurement control	3-11
Temperature units	3-11
Display reading options.....	3-12

Introduction

This section provides information on taking basic measurements. For more detailed information, see [Section 4](#) and the Keithley Instruments Model 6517B Reference Manual.

Changing functions

To avoid erratic operation, always enable zero check ("ZeroCheck" displayed) before selecting one of the other measurement functions (V, I, R, or Q). The **Z-CHK** key controls zero check (see [Zero check](#) for more information)

Voltage measurements

Assuming "BENCH" reset conditions, the basic procedure is as follows:

1. With zero check enabled ("ZeroCheck" displayed), select the volts function by pressing **V**. The **Z-CHK** key is used to enable and disable zero check.
2. Enable or disable guard as needed (see [Guarding](#) for more information). Note that with guard enabled (ON), the "Grd" message is displayed. However, if zero correct is already enabled ("ZCor" displayed), then "Grd" will not be displayed.
3. To achieve optimum accuracy for low voltage measurements, zero correct the Model 6517B. To do this, use the **RANGE** ∇ key to select the lowest measurement range (2V) and press **REL**. With zero correct enabled, the REL indicator is on. Note that with zero correct enabled, the "ZCor" message is displayed. However, if guard is already enabled ("Grd" displayed), then "ZCor" will not be displayed.
4. Select a measurement range or use autoranging:
 - a. To automatically select the most sensitive range, enable autorange. The **AUTO** key enables and disables autorange. When enabled, the AUTO annunciator is on.
 - b. For manual ranging, use the **RANGE** Δ and ∇ keys to select a measurement range consistent with the expected voltage.
5. Connect the test cable(s) to the voltage to be measured. [Figure 3-1A](#) shows connections for unguarded measurements, and [Figure 3-1B](#) shows connections for guarded measurements.

WARNING *Hazardous voltage may be present on the inner shield of the triax cable when GUARD is on. A safety shield connected to safety earth ground (as shown in [Figure 3-1B](#)) should be used for voltage measurements at or above 30V.*

CAUTION *Do not apply more than 250V peak (DC to 60Hz) to the input or instrument damage may occur.*

6. Press **Z-CHK** to disable zero check and take a reading from the display.

Figure 3-1
Voltage measurements

A. Unguarded (GUARD off)

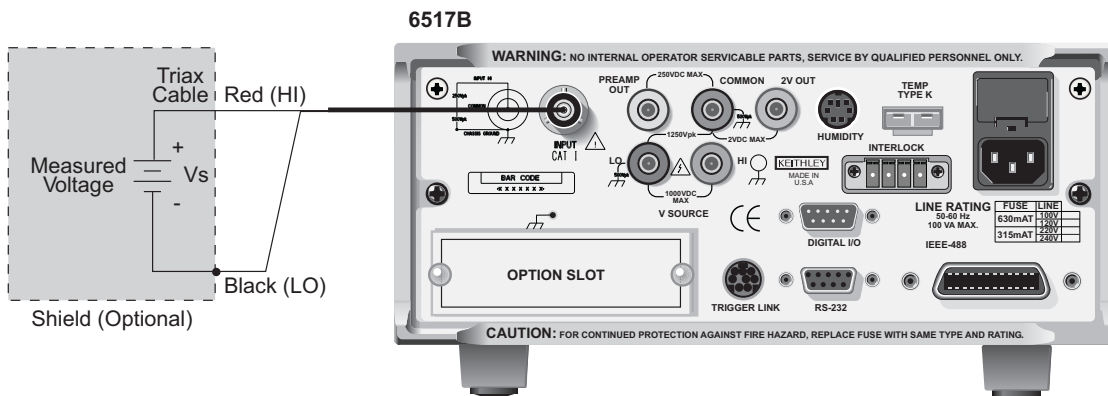

B. Guarded (GUARD on)

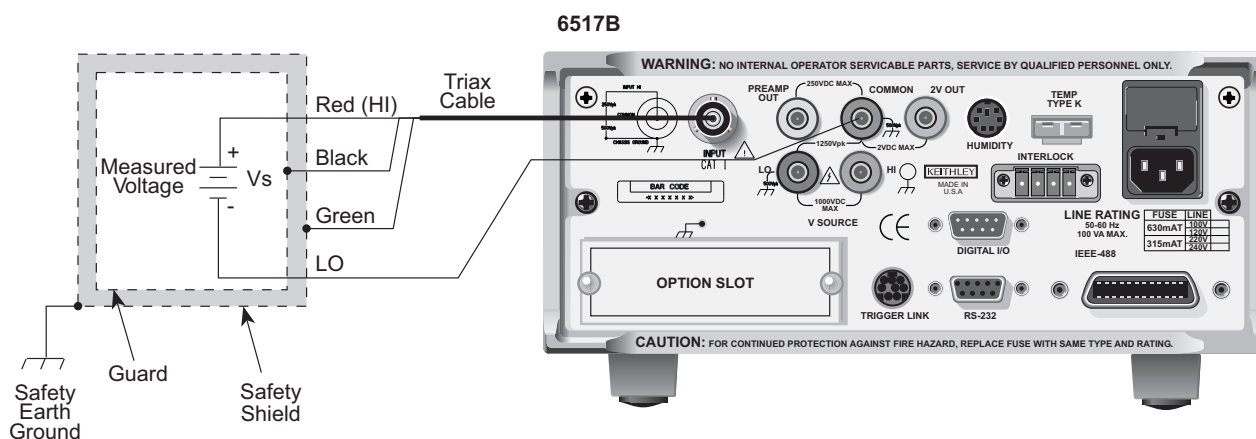

Guarding

Guarding should be used for high impedance ($>10^9\Omega$) voltage measurements and for voltage measurements when using long input cables. In a high impedance circuit, guarding greatly reduces leakage currents. When using long input cables, guarding cancels the effects of cable capacitance that can significantly slow down the measurement response time.

When GUARD is enabled, the INPUT triax connector is reconfigured to apply the guard potential to the inner shell of the INPUT triax connector. With this configuration, the COMMON banana jack is used for input low. [Figure 3-1](#) shows both the guarded and unguarded configurations for the INPUT connector.

Perform the following steps to enable or disable guard:

1. Press **CONFIG** and then **V** to display the volts configuration menu.
2. Use the **◀** and **▶** keys to place the cursor (blinking menu item) on **GUARD** and press **ENTER**.
3. Place the cursor on the desired selection (**OFF** to disable or **ON** to enable) and press **ENTER**.
4. Use the **EXIT** key to back out of the menu.

Current measurements

Assuming “BENCH” reset conditions, the basic procedure is as follows:

1. With zero check enabled (“ZeroCheck” displayed), select the amps function by pressing I. The **Z-CHK** key is used to enable or disable zero check.
2. To achieve optimum accuracy for low current measurements, zero correct the Model 6517B. To do this, use the **RANGE** ∇ key to select the lowest measurement range (20pA) and press **REL**. With zero correct enabled, the REL indicator is on, and the message “ZCor” is displayed.
3. Select a measurement range or use autoranging:
 - a. To automatically select the most sensitive range, enable autorange. The **AUTO** key enables and disables autorange. When enabled, the AUTO annunciator is on.
 - b. For manual ranging, use the **RANGE** Δ and ∇ keys to select a measurement range consistent with the expected current.
4. Connect the instrument to the current to be measured as shown in [Figure 3-2](#).

CAUTION Do not apply more than 250V peak (DC to 60Hz; 10 seconds per minute maximum on mA ranges), or instrument damage may occur.

5. Press **Z-CHK** to disable zero check and take a reading from the display. To disable zero correct, enable zero check and then press **REL**.

Figure 3-2

Current measurements

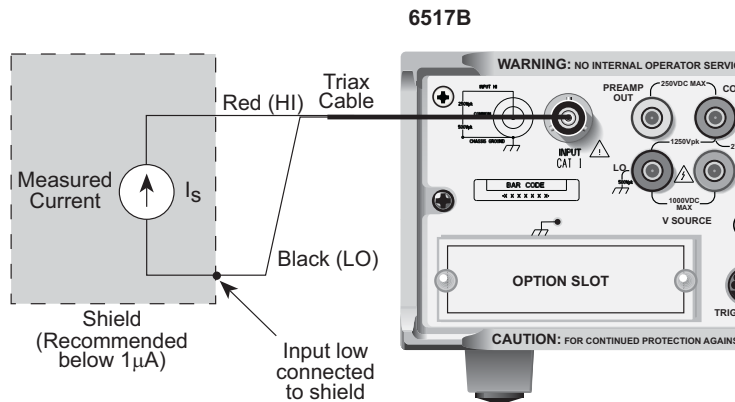

CAUTION: Maximum Input = 250V peak (DC to 60Hz) ; 10s per minute maximum on mA ranges.

Resistance measurements

NOTE Accurate high resistance measurements require the use of a low-leakage test fixture.

The following procedure requires “BENCH” default settings (see [Restoring bench defaults](#) for more information).

1. With zero check enabled (“ZeroCheck” displayed), select the ohms function by pressing **R**.
2. Select **Auto V-Source ohms**. In this mode, the V-Source is automatically set to a voltage (nominally 40V or 400V) that optimizes measurement accuracy (see [Auto V-Source](#) for more information). Note that default “BENCH” settings selects Manual V-Source ohms. In this mode, you must manually set the V-Source level for the measurement. See [Section 4](#) for details on using the V-Source.

<p>WARNING <i>Selecting Auto V-Source ohms may set the V-Source to 400V. Hazardous voltages may be present on the output and guard terminals that could cause personal injury or death.</i></p>
--

3. Select a measurement range or use autoranging:
 - a. To automatically select the most sensitive range, enable autorange. The **AUTO** key enables and disables autorange. When enabled, the AUTO annunciator is on.
 - b. For manual ranging, use the **RANGE** Δ and ∇ keys to select a measurement range consistent with the expected resistance.
4. Connect the Model 6517B to the test fixture. Generic connections are shown in [Figure 3-3](#). Note that this connection scheme requires that ammeter LO be internally connected to V-Source LO (see [Configuring V-Source](#) for more information). For optimum accuracy, leakage currents in the test fixture can be cancelled by performing REL on the current component of the measurement (see [Amps Rel](#) for more information).
5. Disable zero check by pressing **OPER**, then press **Z-CHK** to source voltage to the test fixture device under test (DUT).
6. Take a reading from the display.
7. Place the V-Source in standby when finished by again pressing **OPER**.

WARNING Hazardous voltages may be present on the output and guard terminals. To prevent electrical shock that could cause injury or death, **NEVER** make or break connections to the Model 6517B while the output is on. Power off the equipment from the front panel or disconnect the main power cord from the rear of the Model 6517B before handling cables connected to the outputs. Putting the equipment in standby mode does not guarantee that the outputs are not powered if a hardware or software fault occurs.

Figure 3-3
Resistance measurements

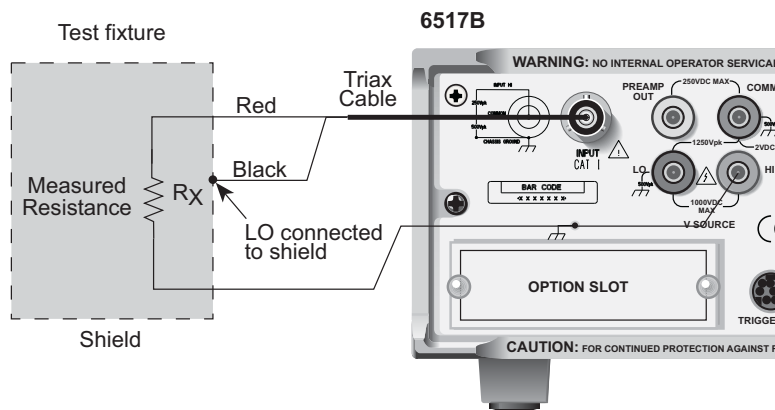

Note: V-Source low internally connected to electrometer low.

Auto V-Source

With Auto V-Source selected, the V-Source is automatically set for either 40V or 400V. For the 2M Ω through 200G Ω ranges, the V-Source is set to 40V. For the 2T Ω through 200T Ω ranges, a 400V test voltage is used. With Manual V-Source selected, you can manually set the voltage level of the V-Source.

Perform the following steps to select the V-Source mode for the ohms function:

1. Press **CONFIG** and then **R** to display the ohms configuration menu.
2. Use the **◀** and **▶** keys to place the cursor (blinking menu item) on **VSOURCE** and press **ENTER**.
3. Place the cursor on **AUTO** (Auto V-Source ohms) or on **MANUAL** (Manual V-Source ohms) and press **ENTER**.
4. Use the **EXIT** key to back out of the menu.

Amps Rel

Amps Rel is used to cancel leakage current in a test fixture for ohms measurements. This procedure assumes that steps 1 through 4 of the Resistance Measurements procedure have been performed. Perform the following steps:

1. With the V-Source in standby, remove the DUT from the test fixture.
2. Select the **Amps (I)** function and disable zero check. Make sure REL is disabled.

3. Place the V-Source in operate by pressing **OPER**. The VOLTAGE SOURCE OPERATE indicator is on when in operate.
4. Select the lowest possible measurement range to display the leakage current in the test fixture.
5. Enable relative (REL annunciator on) by pressing **REL**. This zeroes the display, canceling the leakage current reading.
6. Press **OPER** to place the V-Source in standby and enable zero check.
7. Perform the following steps to establish the amps Rel value for the ohms function.
 - a. Press **CONFIG** and then **R** to display the ohms configuration menu.
 - b. Use the ◀ and ▶ keys, place the cursor (blinking menu item) on **AMPSREL** and press **ENTER**.
 - c. Place the cursor on **YES** and press **ENTER** to use the amps Rel value for the ohms measurement.
 - d. Use the **EXIT** key to back out of the menu.
8. Re-install the DUT in the test fixture.
9. Select the **ohms (R)** function and proceed to step 5 of the Resistance Measurement procedure.

Resistivity measurements

NOTE The following procedure to measure resistivity (surface or volume) requires the use of the Keithley Instruments Model 8009 Resistivity Test Fixture. Refer to the Model 8009 Instruction Manual for details on using the test fixture.

The following procedure requires “BENCH” reset conditions (see [Restoring bench defaults](#) for more information).

1. With zero check enabled (“ZeroCheck” displayed), select the ohms function by pressing **R**.
2. Select **Auto V-Source ohms**. In this mode, the V-Source is automatically set to a voltage (nominally 40V or 400V) that optimizes measurement accuracy (see [Auto V-Source](#) for more information). Note that “BENCH” reset conditions selects Manual V-Source ohms. In this mode, you must manually set the V-Source level for the measurement (see [Voltage source](#) for more information).

<p>WARNING <i>Selecting Auto V-Source ohms may set the V-Source to 400V. Hazardous voltages may be present on the output and guard terminals that could cause personal injury or death.</i></p>
--

3. Select a measurement range or use autoranging:
 - a. To automatically select the most sensitive range, enable autorange. The **AUTO** key enables and disables autorange. When enabled, the AUTO annunciator is on.
 - b. For manual ranging, use the **RANGE** keys (△ and ▽) to select a measurement range consistent with the expected resistance.
4. Connect the Model 6517B to the Model 8009 test fixture as shown in [Figure 3-4](#), and set the switch on the test fixture to the desired measurement type (Surface or Volume).
5. Select the resistivity measurement mode as follows:
 - a. Press the **CONFIG** and then **R** to display the ohms configuration menu.
 - b. Use the cursor keys (◀ and ▶) to place the cursor (blinking menu item) on **MEAS-TYPE** and press **ENTER**.

- c. Place the cursor on **RESISTIVITY** and press **ENTER**.
- d. Cursor position (**SURFACE** or **VOLUME** menu item blinking) indicates the selected measurement type. The Model 6517B senses the switch position (surface or volume) on the Model 8009 through the interlock cable, and automatically configures the instrument for that measurement type:
 - **SURFACE**: If Surface is the selected measurement type, you do not have to proceed any further into the menu structure. Use the EXIT key to exit from the menu.
 - **VOLUME**: If Volume is the selected measurement type, proceed as follows to specify the thickness of the sample:
 - 1) With the cursor on **VOLUME**, press **ENTER** to display the parameters menu for volume.
 - 2) Place the cursor on **THICKNESS** and press **ENTER**. The present thickness parameter for the sample will be displayed.
 - 3) Use the cursor keys (◀ and ▶) and the **RANGE** keys (△ and ▽) to specify the thickness (in millimeters) of the sample, and then press **ENTER**.
 - 4) Use the **EXIT** key to back out of the menu structure.
6. Disable zero check by pressing **Z-CHK**.
7. Press **OPER** to source voltage to the DUT and, after an appropriate electrification time, take a reading from the display. Typically, an electrification time of 60 seconds is used.
8. Place the V-Source in standby when finished by again pressing **OPER**.

WARNING *Hazardous voltages may be present on the output and guard terminals. To prevent electrical shock that could cause injury or death, NEVER make or break connections to the Model 6517B while the output is on. Power off the equipment from the front panel or disconnect the main power cord from the rear of the Model 6517B before handling cables connected to the outputs. Putting the equipment in standby mode does not guarantee that the outputs are not powered if a hardware or software fault occurs.*

Figure 3-4
Resistivity measurements

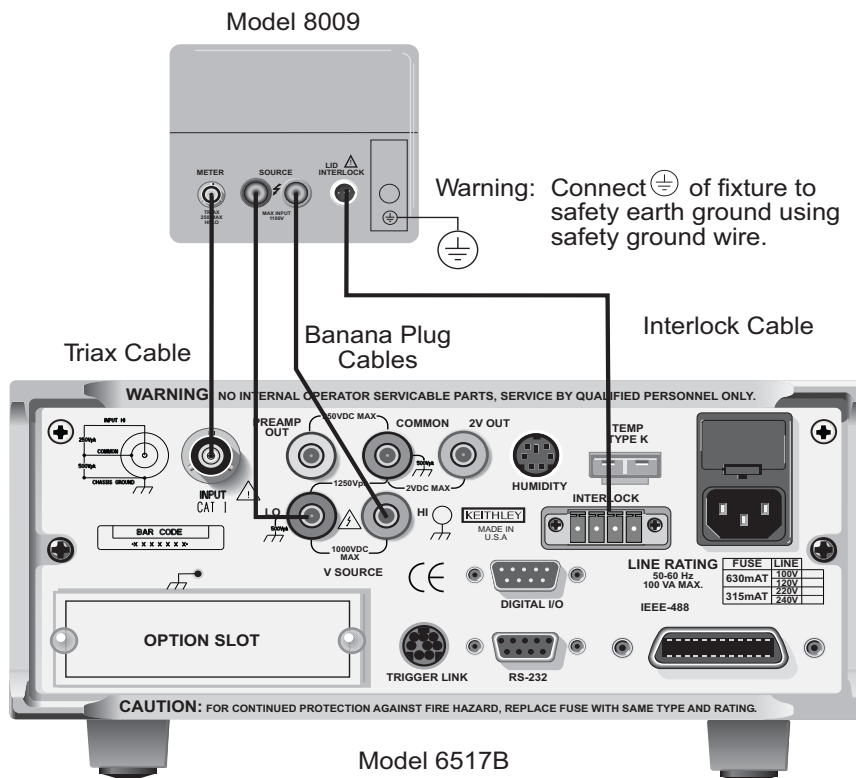

Charge measurements

Assuming “BENCH” reset conditions, the basic procedure is as follows:

1. With zero check enabled (“ZeroCheck” displayed), select the coulombs function by pressing **Q**.
2. Select a measurement range or use autoranging:
 - a. To automatically select the most sensitive range, enable autorange. The **AUTO** key enables and disables autorange. When enabled, the AUTO annunciator is on.
 - b. For manual ranging, use the **RANGE** keys (Δ and ∇) to select a measurement range consistent with the expected charge reading.
3. Connect the test cable (see Figure 3-5) to the input of the Model 6517B. With the input open, disable zero check. If needed, press **REL** to zero the display.
4. Connect the instrument to the charge to be measured as shown in Figure 3-5.

CAUTION Do not apply more than 250V peak (DC to 60Hz) or instrument damage may occur.

5. Take a reading from the display. The reading can be reset to zero by enabling zero check. If you wish to have the reading reset to zero when a specified charge level is reached, enable Auto Discharge as explained in the following paragraph.

Auto discharge

When enabled, Auto Discharge is used to automatically reset the charge reading to zero when the specified charge level is reached. After the integrator resets, the charge measurement process simply restarts at zero. Perform the following steps to enable or disable Auto Discharge.

1. Press the **CONFIG** key and then **Q** to display the coulombs configuration menu.
2. Use the cursor keys (◀ and ▶) to place the cursor (blinking menu item) on **AUTO-DISCHARGE** and press **ENTER**.
3. Perform step a to enable Auto Discharge or perform step b to disable it:
 - a. Enable Auto Discharge: Place the cursor on **ON** and press **ENTER** to display the present discharge level. Use the cursor keys (◀ and ▶) and the **RANGE** keys (△ and ▽) to set a different discharge level and press **ENTER**.
 - b. Disable Auto Discharge: Place the cursor on **OFF** and press **ENTER**.
4. Use the **EXIT** key to exit from the menu.

Figure 3-5
Charge measurements

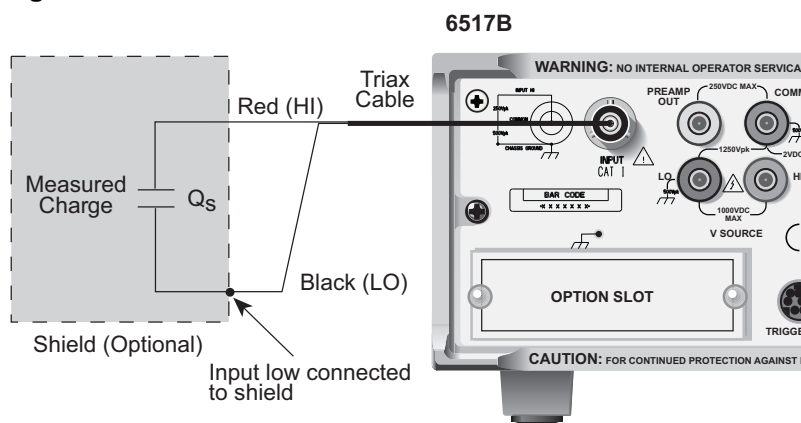

Temperature and humidity measurements

The Model 6517B can make external temperature measurements from -25°C to 150°C using the Keithley Instruments Model 6517-TP type K thermocouple (which is a supplied accessory).

The Model 6517B can make relative humidity measurements (0 to 100%) using the Keithley Instruments Model 6517-RH humidity probe (which is available as an option).

Connections

The Model 6517-TP (thermocouple) and Model 6517-RH (humidity probe) connect to the rear panel connectors labeled "TEMP TYPE K" and "HUMIDITY" as shown in [Figure 3-6](#).

NOTE Keithley Instruments recommends that the thermocouple junction of the Model 6517-TP be electrically insulated from ground and voltage potentials. Erroneous readings will result if the thermocouple comes in contact with ground or a voltage potential.

Figure 3-6
External temperature and humidity measurements

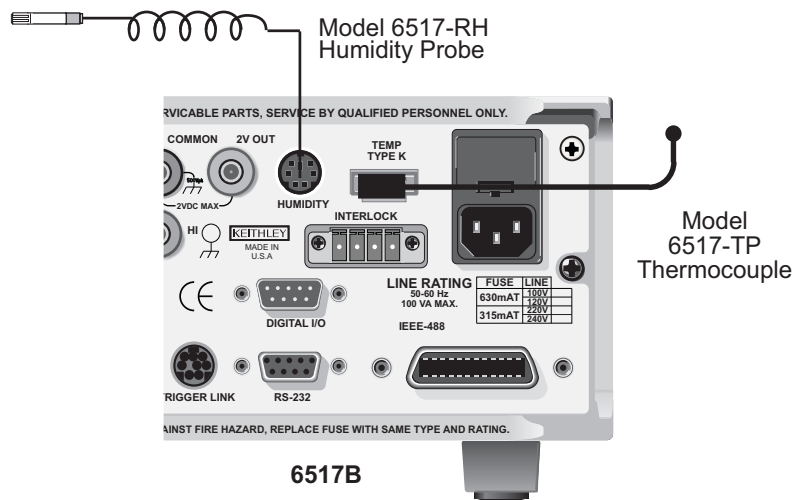

Measurement control

BENCH reset disables temperature and humidity measurements. These measurements can be enabled from the front panel as follows:

1. Press **MENU** to display the main menu.
2. Use the cursor keys (◀ and ▶) to place the cursor (blinking menu item) on **GENERAL** and press **ENTER** to display the menu items of the general menu.
3. Place the cursor on **A/D-CONTROLS** and press **ENTER** to display the A/D controls menu.
4. Place the cursor on **DATA-STAMP** and press **ENTER**. The present control state for temperature and humidity will be displayed. OFF indicates that the measurement is disabled, while **ON** indicates that the measurement is enabled.
5. To change the control state for temperature and humidity, place the cursor on the appropriate menu item and use the **RANGE** keys (△ and ▽) to toggle the control state. With the desired states for temperature and humidity displayed (ON or OFF), press **ENTER**.
6. Use the **EXIT** key to back out of the menu.

Temperature units

All temperature readings by the Model 6517B can be displayed in Celsius (°C), Fahrenheit (°F), or Kelvin (K). BENCH reset selects Celsius (°C) measurement units. Perform the following steps to change units:

1. Press **MENU** to display the main menu.
2. Use the cursor keys (◀ and ▶) to place the cursor (blinking menu item) on **GENERAL** and press **ENTER** to display the menu items of the general menu.
3. Place the cursor on **DISPLAY** and press **ENTER** to display the SET READING DISPLAY menu.
4. Place the cursor on **TEMP-UNITS** and press **ENTER**. The blinking cursor indicates the present temperature units selection.
5. To change temperature units, place the cursor on the desired selection (°C, K, or °F) and press **ENTER**.
6. Use the **EXIT** key to back out of the menu.

Display reading options

Temperature and humidity readings are available as multiple (NEXT) displays. Using multiple displays, temperature and humidity readings can accompany each normal A/D measurement, and they can be included as data storage elements for each reading stored in the buffer (see [Multiple displays](#) for more information).

External temperature and humidity are selected as data store elements from the data store configuration menu (see [Buffer \(data store\)](#) for more information).

Section 4

Measurement Options

In this section:

Topic	Page
Introduction	4-3
Multiple displays	4-3
Menus	4-5
Navigating menus	4-6
Voltage source	4-7
Connections	4-7
Basic operation	4-9
Configuring V-Source	4-9
Relative	4-9
Configuring rel	4-10
Zero check	4-10
Zero correct	4-10
Triggering	4-10
Idle	4-11
Control sources	4-12
Device action	4-12
Output trigger	4-12
Counters	4-12
Bench default setup	4-12
Speed	4-13
Configuring speed	4-13
Resolution	4-13
Configuring resolution	4-13
Filter	4-13
Filter types	4-14
Filter modes	4-14
Median filter	4-14
Configuring filters	4-15
Buffer (data store)	4-15
Storing readings	4-15

Topic	Page
Math.....	4-16
Selecting and configuring math	4-17
Enabling math.....	4-18
Additional math operations	4-18
Test sequences.....	4-19
Configuring test sequences	4-19
Connections.....	4-20
Running a test	4-21
Internal scanning	4-21
Configure internal scanner.....	4-21
Perform the scan	4-21
Close/open channels.....	4-22
External scanning	4-22
Trigger connections	4-23
Configure external channels.....	4-23
Perform the scan	4-23

Introduction

This section describes the details of taking measurements. Configuration options, triggers, reading storage, and scanning are just a few of the topics discussed. You will find this information useful whether operating the Model 6517B from the front panel or IEEE-488 bus.

Multiple displays

Each measurement function and some operations provide multiple displays by using the bottom line of the front panel. These multiple displays provide multiple type measurements, show a reading in a different form, or give additional information about the reading.

Multiple displays are summarized in this section. All the multiple displays are shown in [Table 4-1](#).

The **NEXT** and **PREV** (previous) **DISPLAY** keys scroll through the multiple displays for the selected function or operation. The multiple display mode can be cancelled by pressing and holding in either key.

Table 4-1
Multiple displays by function

Function	Next display
All	Time, day, and date Bar graph Zero-centered bar graph Maximum and minimum values Relative and actual values Calculated and actual values Limits bar graph Relative humidity and external temperature Change from calibration temperature
Ohms (R)	Source (V) and measure (I) values
Buffer	Relative humidity and external temperature, V-Source value, maximum reading, minimum reading, average reading, standard deviation, and print buffer data



Time, day, and date: This display provides the time, day of week, and the date. The time, date, and format (12-hour or 24-hour) are set from the **CLOCK** option of the **GENERAL MENU** (see [Menus](#) for more information).



Bar graph: The bar graph is a graphical representation of the reading with zero at the left end. Each full segment of the bar represents approximately 4% of the range limit.



Limits: This display provides the result of the limit test. The graphical representation of the reading is shown on a zero-centered bar graph. If the reading is between the specified high and low limits, the PASS message is displayed. If the reading is outside of the limits, the FAIL message is displayed. Limits are set and enabled from the LIMITS option of the Main Menu.



Zero-centered bar graph: The zero-centered bar graph is a graphical representation of the reading using plus/minus limits with zero in the center. Each full segment represents 10% of the limit.



Maximum and minimum: This display shows the maximum and minimum readings that have occurred since the display was entered. Maximum and minimum values are reset by pressing the present function key or by leaving the display.



Relative and actual: This display is used with the REL (relative) feature. While the top line shows the result of the rel operation, the bottom line shows the actual (raw) reading.



Calculated and actual: This display is used with a math calculation. While the top line provides the result of the math calculation, the bottom line provides the raw reading.



Relative humidity and external temperature: This display is used to display the relative humidity and external temperature readings. Note that the appropriate option (see Section 1 of the Reference Manual) must be connected and enabled.



Change from cal temp: With temperature readings enabled, this display indicates the difference between the present internal temperature and the internal temperature when the instrument was last calibrated.



Measure/source: This display is used to display the measured current and the V-Source level for ohms measurements.



Buffer: When in RECALL, there are seven displays for buffer readings:

- Relative humidity (RH) and temperature (ET)
- V-Source value
- Maximum reading (shown at left)
- Minimum reading
- Average reading (shown at left)
- Standard deviation
- Print buffer data



Menus

There are two basic menu structures used by the Model 6517B: The main menu and the CONFIG menus. The main menu accesses items for which there are no dedicated keys. The CONFIG menus are used to configure measurement functions and other instrument operations.

Table 4-2 summarizes main menu selections. Table 4-3 and Table 4-4 show configuration settings for the measurement functions and instrument operations.

Figure 4-1
Main menu display



Table 4-2
Main menu summary

Option	Description
SAVESETUP	Save and restore setups stored in memory, set power-on defaults, and return unit to default conditions.
COMMUNICATION	Select and configure interface (GPIB or RS-232).
CAL	Calibrate the Model 6517B, perform offset adjustments, and check calibration date.
TEST	Perform self-tests (see Reference Manual).
LIMITS	Configure unit to perform limit tests.
STATUS-MSG	Enable/disable status message mode.
GENERAL	Control output lines of digital output port, check serial number of unit and firmware revision levels, control line-sync, limit control and data stamp, configure timestamp, set reading display, and set real-time clock.

Table 4-3
Configuration settings for each measurement function

Function	Speed	Filter	Resolution	Autorange limits	Damping	Guard	External feedback	Amps rel	Meas type*	V-Source**	Auto discharge
Volts	•	•	•	•		•	•				
Amps	•	•	•	•	•						
Ohms	•	•	•	•	•			•	•	•	
Coulombs	•	•	•	•							•

*Resistance or resistivity

**Auto or manual

Table 4-4
Configuration settings for instrument operations

Option	Description
CONFIG REL	Set rel (relative) value and enable.
CONFIG FILTER	Select and configure averaging, and median filters.
CONFIG MATH	Select and configure math calculation: polynomial, percent, percent deviation, ratio or log10.
CONFIG TRIG	Select and configure basic or advanced trigger model.
CONFIG SEQ	Select and configure test sequence.
CONFIG STORE	Configure data store: set count, control, timestamp, elements and display, and clear buffer.
CONFIG VOLTAGE SOURCE*	Configure V-Source: range, V-limit, resistive I-limit, and meter connect.
CONFIG CARD	Select and configure internal or external scanning.
CONFIG NEXT	Change the scale for the zero-center bar graph.
CONFIG Z-CHK	Set whether readings are shown in Zero-Check mode.

*To access the V-Source menu, press **CONFIG** and then any one of the **VOLTAGE SOURCE** keys.

Navigating menus

Use the following rules to navigate through the menu structures. [Table 4-5](#) summarizes the front panel keys used for navigation.

- From the instrument's normal state of displaying readings, you can:
 - View a configuration menu by pressing **CONFIG** and then the desired function or operation key.
 - View the top level of the main menu by pressing the **MENU** key.
- The unit is returned to the normal reading display by:
 - Pressing **EXIT** or **MENU** from the top level of the main menu.
 - Pressing **EXIT** from the top level of a configuration menu.
 - Pressing a measurement function key from within a menu.
- Pressing the **ENTER** key selects an item and, if further definition is needed, moves down within the menu structure. Pressing the **EXIT** key backs up within a menu structure.
- The cursor position is denoted by a blinking menu item or parameter. The cursor is moved from one item to the next using the cursor keys (◀ and ▶). To select an item, highlight it with the cursor, then press **ENTER**.
- A displayed arrow (◀ or ▶) on the bottom line indicates there is more information or additional menu items to select from. When ◀ is displayed, use the ▶ cursor key. The cursor keys have an auto-repeat feature.

6. A numeric parameter is keyed in by placing the cursor on the digit to be changed, and pressing the **RANGE** keys (Δ and ∇) to increment or decrement the digit.
7. A change is only executed when the **ENTER** key is pressed. Entering an invalid parameter generates an error, and the entry is ignored. Changes are also ignored if an **EXIT** is performed.
8. The **INFO** key can be used anywhere in a menu to display helpful information messages concerning operation. To cancel an information message and remain in the menu, press **INFO** a second time, **EXIT**, or **ENTER**. Pressing a function key cancels **INFO** and the menu, and returns the instrument to a reading display.

Table 4-5
Menu summary

Action	Description
CONFIG-(function)	Press the CONFIG key, then a function key (for example, V) to view the top level of a function configuration menu.
MENU	Press the MENU key to view the top level of the main menu; the operations that have no corresponding key are included in the main menu.
◀ or ▶	Use the cursor keys to move the highlighted cursor among menu selections, or the digits of a parameter value, or change channels on the scanner.
RANGE Δ	Use the RANGE keys to increment and decrement digits of a parameter value.
RANGE ∇	
ENTER	Accepts menu selection or data entry.
EXIT	Cancels menu selection changes and returns to the display of the previous menu level.
INFO	Displays context-sensitive information about the present menu level; toggles information message on/off.

Voltage source

The built-in, bipolar, 1W voltage source can output up to $\pm 1000V$. With the instrument in the normal measurement mode, the programmed V-Source level is shown on the bottom line of the display.

Connections

WARNING *Hazardous voltages may be present on the output and guard terminals. To prevent electrical shock that could cause injury or death, NEVER make or break connections to the Model 6517B while the output is on. Power off the equipment from the front panel or disconnect the main power cord from the rear of the Model 6517B before handling cables connected to the outputs. Putting the equipment in standby mode does not guarantee that the outputs are not powered if a hardware or software fault occurs.*

If used as an independent source, voltage is available at the V-SOURCE HI and LO terminals on the rear panel (see [Figure 4-2](#)). If used as an FVMI (force voltage measure current) source, V-Source LO can be internally connected to ammeter LO from the METER CONNECT option of the CONFIGURE V-SOURCE menu (see [Configuring V-Source](#) for more information). [Figure 4-3](#) shows the connections for this configuration.

Figure 4-2
Independent V-Source connections

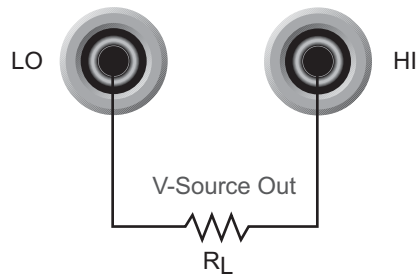

A. Basic Connections

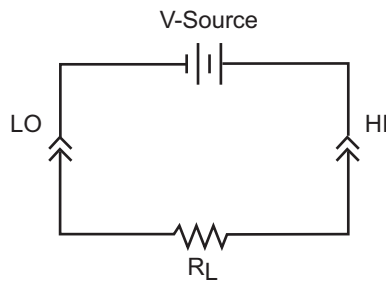

B. Equivalent Circuit

Figure 4-3
FVMI connections

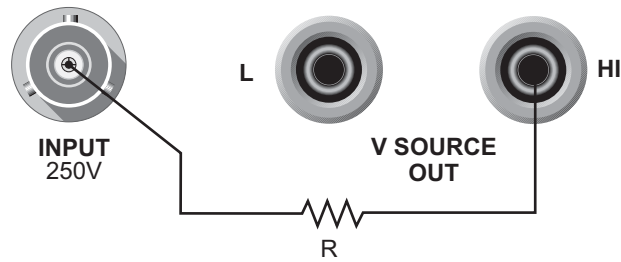

Note: V-SOURCE LO connected to ammeter input LO via METER-CONNECT option of CONFIGURE V-SOURCE Menu.

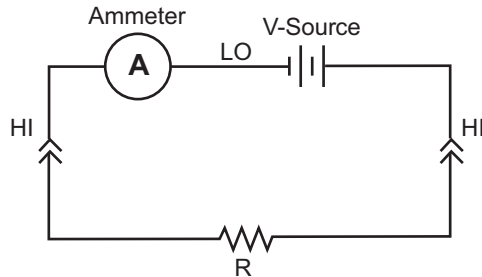

Basic operation

Basic operation simply consists of setting the V-Source level and placing the V-Source in OPERATE to output the voltage. Other V-Source operations are performed from the CONFIGURE V-SOURCE menu (see [Configuring V-Source](#) for more information) to select range (100V or 1000V), set voltage limit, select resistance current limit, and control the LO-to-LO connection between the V-Source and the ammeter.

Setting V-Source level: The V-Source level is set with the instrument in the normal measurement mode. The **VOLTAGE SOURCE** Δ and ∇ keys, and the cursor keys (\blacktriangleleft and \blacktriangleright) are used to adjust the voltage level. Pressing any one of these four keys will enable the V-Source edit mode. The flashing digit on the V-Source display indicates the cursor position. Use the cursor keys to place the cursor on the desired digit, and use the **VOLTAGE SOURCE** Δ and ∇ keys to adjust the level. Polarity can be changed by placing the cursor on the polarity sign, and pressing **VOLTAGE SOURCE** Δ and ∇ .

Sourcing voltage: The displayed voltage level is applied to the output terminals when the instrument is placed in operate by pressing the **OPER** key. In operate, the VOLTAGE SOURCE OPERATE indicator is on. Pressing **OPER** a second time places the V-Source in standby.

Configuring V-Source

Perform the following steps to configure the V-Source:

1. Press the **CONFIG** key and one of the **VOLTAGE SOURCE** keys to display the following configuration menu:

RANGE: Select the 100V range or 1000V range.

V-LIMIT: Control (on/off) and set a voltage limit (absolute value).

RESISTIVE LIMIT: Control (on/off) the resistive (1M Ω) current limit.

METER CONNECT: Control (on/off) the internal connection between V-Source LO and ammeter LO.

2. Use the menu items to configure the V-Source. A menu item is selected by placing the cursor on it and pressing **ENTER**. Options for a menu item are selected in the same way. Parameter values are changed using the cursor keys (\blacktriangleleft and \blacktriangleright) and the **RANGE** keys (Δ and ∇), and then pressing **ENTER**.
3. Use the **EXIT** key to back out of the menu structure.

Relative

Rel subtracts a reference value from actual readings. When rel is enabled, the instrument uses the present reading as a relative value. Subsequent readings will be the difference between the actual input value and the rel value.

$$\text{Actual Input} - \text{Reference} = \text{Displayed Reading}$$

The rel (relative) operation is enabled by pressing the **REL** key (REL annunciator turns on). Pressing **REL** a second time disables rel. You can also enter and enable a rel value from the CONFIG-REL display.

A rel value can be established for each measurement function. The state and value of rel for each measurement function are saved when changing functions. Once a rel value is established for a measurement function, the value is the same for all ranges.

Configuring rel

To check or change a rel value for a measurement function, perform the following steps:

1. Select the desired measurement function.
2. Press the **CONFIG** key and then the **REL** key to display the present rel value.
3. Use the cursor keys (◀ and ▶) and the **RANGE** keys (△ and ▽) to change the rel value and press **ENTER**. The instrument will return to the normal display state with rel enabled.

Zero check

With zero check enabled ("ZeroCheck" displayed), the input signal is routed to low through a high impedance shunt. For volts, amps, and ohms measurements, zero check should be enabled when connecting or disconnecting input signals. For charge measurements, zero check should be disabled. If left enabled, the charge will dissipate through the 10MΩ shunt.

The Z-CHK key is used to enable and disable zero check. To ensure proper operation, always enable zero check before changing functions (V, I, R, or Q).

Zero correct

The Z-CHK and REL keys work together to cancel (zero correct) any internal offsets that might upset accuracy for voltage and current measurements.

Perform the following steps to zero correct the volts or amps function:

1. Select the **V** or **I** function.
2. Enable Zero Check.
3. Select the range that will be used for the measurement, or select the lowest range.
4. Press **REL** to zero correct the instrument. The REL indicator turns on and the "ZCor" message is displayed. For the volts function, the "ZCor" message will not be displayed if guard was already enabled ("Grd" displayed).
5. Press **Z-CHK** to disable zero check.
6. Readings can now be taken in the normal manner. The instrument will remain zeroed even if the instrument is upranged. If downranged, re-zero the instrument.
7. To disable zero correct, first enable zero check and then press **REL**.

Triggering

The following overview is intended to acquaint you with triggering. For a complete explanation, see the Model 6517B Reference Manual. Triggering is configured from the Trigger Configuration menu which is accessed by pressing **CONFIG** and then **TRIG**.

There are two trigger modes for the Model 6517B; basic and advanced. These two trigger modes are summarized by the simplified trigger models shown in [Figure 4-4](#) and [Figure 4-5](#). As shown in the drawings, the basic trigger model uses one layer of operation, while the advanced trigger model uses three layers to provide more trigger options.

Figure 4-4
Basic trigger model (simplified)

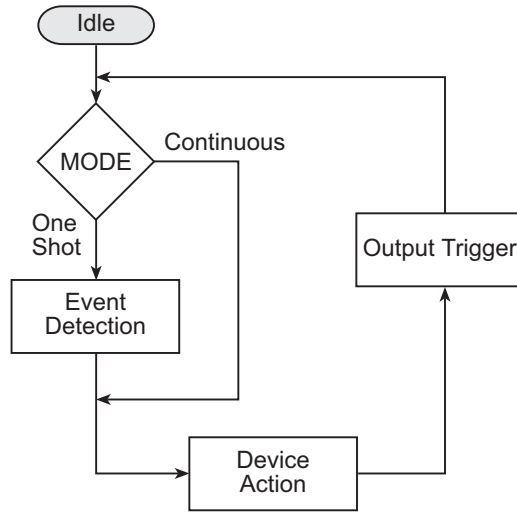
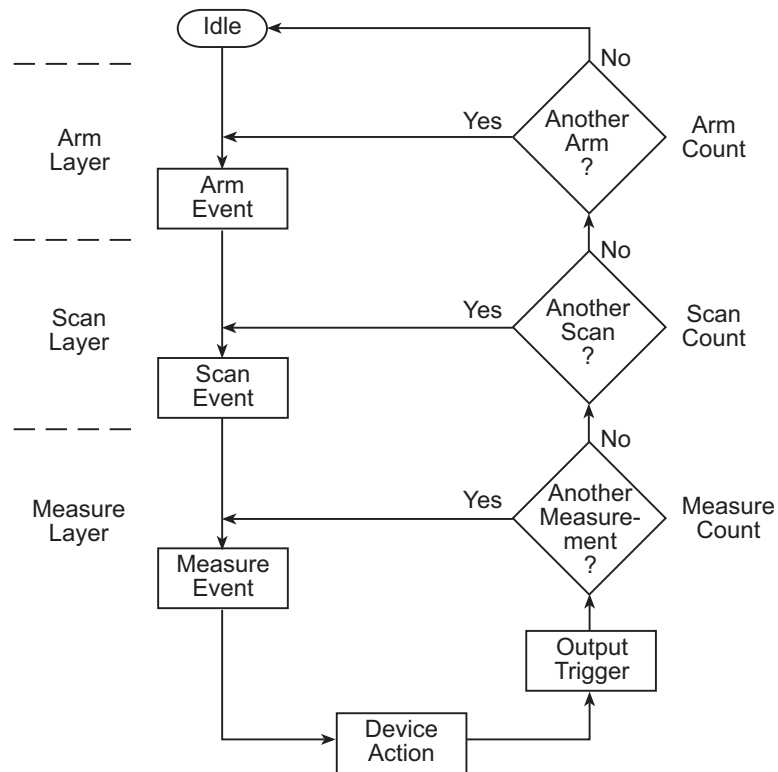

Figure 4-5
Advanced trigger model (simplified)



Idle

The instrument is in idle whenever it is not within one of the layers of the trigger model. When the Model 6517B is taken out of idle by pressing **TRIG** (or sending `:INIT` or `:INIT:CONT ON` over the bus), the ARM indicator turns on and operation proceeds in the trigger model.

Control sources

With advanced triggering and basic one-shot triggering, operation is controlled by control sources which hold up operation until the programmed event occurs. Basic one-shot triggering uses one control source, while advanced triggering uses three control sources. The control sources are described below.

- **Immediate:** Event detection is immediately satisfied, allowing operation to continue.
- **External:** Event detection is satisfied when an input trigger via the EXT TRIG IN connector is received.
- **Manual:** Event detection is satisfied by pressing the TRIG key.
- **GPIB:** Event detection is satisfied when a bus trigger (GET or *TRG) is received.
- **TrigLink:** Event detection is satisfied when an input trigger via the trigger link connector is received. Not available for basic triggering.
- **TIMER:** Event detection is immediately satisfied on the initial pass through the layer. Each subsequent detection is satisfied when the programmed timer interval elapses. Not available in the Arm Layer of the advanced trigger model.
- **Hold:** With this selection, event detection is not satisfied by any of the above control source events and operation is paused. Not available for basic triggering.

If continuous basic triggering is being used, then operation bypasses the control source (as shown in [Figure 4-4](#)) and performs a device action.

Device action

The primary device action is a measurement. However, the device action could include a function change and a channel scan (if scanner is enabled). A channel is scanned (closed) before a measurement is made. When scanning internal channels, the previous channel opens and the next channel closes (break-before-make). Also included in the device action is the internal settling time delay for the relay.

Output trigger

After each measurement (device action), an output trigger pulse occurs and is available at the rear panel of the Model 6517B. When used with an external scanner, each output trigger is used to select the next channel in a scan (see [External scanning](#) for more information).

Counters

All three layers of the advanced trigger model use programmable counters that allow operation to return to or stay in the respective layer. For example, programming the measure layer counter to infinite keeps operation in the measure layer. After each device action, operation loops back to the trigger layer control source. A counter resets when operation loops back to a higher layer (or idle).

Bench default setup

The bench default setup selects advanced triggering and takes the Model 6517B out of idle, sets the control sources of all layers to Immediate, and sets the measure layer counter to infinite. With this trigger model setup, operation simply falls into the measure layer (and stays there) to make continuous measurements.

Speed

SPEED sets the integration time of the A/D converter, the period of time the input signal is measured. The SPEED can be set for each measurement function. The integration time is specified in parameters based on a number of power line cycles (NPLC), where one PLC for 60Hz is 16.67msec and one PLC for 50Hz and 400Hz is 20msec.

In general, the fastest integration time (0.01 PLC) results in increased reading noise and less usable resolution, while the slowest integration time (10 PLC) provides the best common-mode and normal-mode rejection. In-between settings are a compromise between speed and noise.

Configuring speed

Each measurement function can have a unique integration time. Speed is set from the configure function menu structures. The procedure is summarized as follows:

1. Press the **CONFIG** key and then the desired function key.
2. Use the cursor keys to select **SPEED** and press **ENTER** to display the following speed options:
 - NORMAL:** Sets the integration time to 1 PLC.
 - FAST:** Sets the integration time to 0.01 PLC.
 - MEDIUM:** Sets the integration time to 0.1 PLC.
 - HIACCURACY:** Sets the integration time to 10 PLC.
 - SET-SPEED-EXACTLY:** This options prompts you to enter a PLC value (0.01 to 10)
 - SET-BY-RESOLUTION:** Automatically optimizes the integration time for the present resolution setting (see Section 4 of the Reference Manual).
3. Use the menu items to configure speed. A menu item is selected by placing the cursor (blinking menu item) on it and pressing **ENTER**. Parameter values are changed using the cursor keys and the **RANGE** keys, and then pressing **ENTER** (see [Menus](#) for more information on navigating through the menu structure).

For more information, see Section 4 of the Reference Manual.

Resolution

All functions can operate from 3½ to 6½ digits of resolution. Each function can have a unique resolution setting.

Configuring resolution

Perform the following steps to set resolution for a measurement function:

1. Press the **CONFIG** key and then the desired function key.
2. Using the cursor keys, select **RESOLUTION** and press **ENTER** to display the following resolution options:
 - a. **3.5 to 6.5d:** Select one of these options to set the display resolution.
 - b. **AUTO:** This option automatically optimizes the resolution for the present integration time (speed) setting (see Section 5 of the Reference Manual).
3. Set resolution by placing the cursor on the menu option and pressing **ENTER**.

Filter

Filtering stabilizes noisy measurements. The Model 6517B uses a digital filter and a median filter. When a filter is enabled by pressing **FILTER** (FILT annunciator turns on), the selected filter for that measurement function is in effect. Pressing **FILTER** a second time disables the filter.

Filter types

The Model 6517B has two types of digital filters: averaging and advanced. Both types are a simple average of 1 to 100 reading conversions. The difference is a user-programmed “noise window” for the advanced filter. The noise window (expressed as a percentage of range) allows a faster response time to large signal step changes (see [Figure 4-6](#)). See Section 9 of the Reference Manual for complete information on filter types.

Figure 4-6
Filter response/noise window

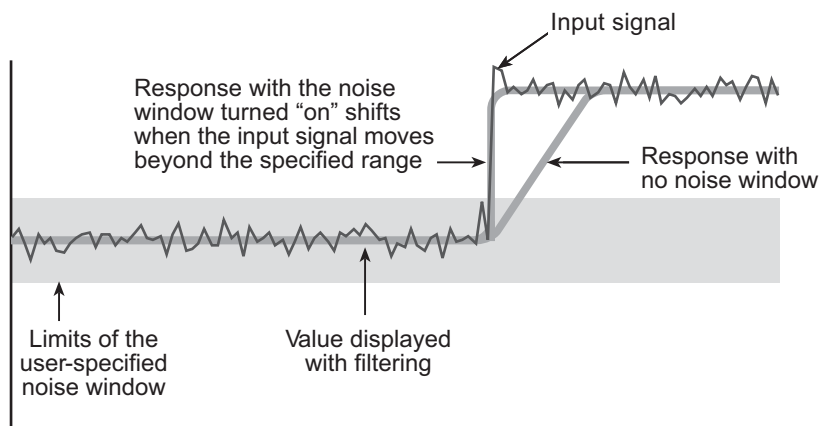

Filter modes

There are two filter modes: moving or repeating. The moving filter uses a first-in, first-out stack. When the stack becomes full, the measurement conversions are averaged, yielding a reading. For each subsequent conversion, the new conversion is placed into the stack, the oldest conversion is discarded, and a new reading is averaged.

For the repeating filter, the stack is filled and the conversions are averaged to yield a reading. The stack is then cleared and the process starts over. See Section 9 of the Reference Manual for complete information on filter modes.

Median filter

Median filtering uses the middlemost reading from a group of sample readings arranged in ascending order. For example, assume the following readings:

20V, 1V, 3V

They are then arranged in ascending order as follows:

1V, 3V, 20V

The median (middlemost) reading from the above sample group is 3V.

The number of sample readings is determined by the specified rank as follows:

$$\text{Sample readings} = (2 \times R) + 1$$

Where: R is the selected rank (1 to 5)

For example, a rank of 4 will use the last nine readings to determine the median;
 $(2 \times 4) + 1 = 9$.

Each new reading replaces the oldest reading, and the median is then determined from the updated sample group of readings.

Configuring filters

Each measurement function has its own filter configuration. Perform the following steps to configure filter:

1. Select the measurement function.
2. Press **CONFIG** and then **FILTER** to display the following menu items:
AVERAGING:This item is used to control and configure the digital filter
MEDIAN:This item is used to control and configure the median filter
3. The menu structure for the two filters (averaging and median) is shown as follows:
 - a. **AVERAGING** (digital) filter options (**TYPE** is used to select the digital filter type):
 - **NONE:** Disables the digital filter.
 - **AVERAGING:** Selects the averaging filter and prompts you to enter the number of readings to average (stack size).
 - **ADVANCED:** Selects the advanced filter and prompts you to enter the number of readings to average (stack size); after entering the stack size, you are then prompted to enter the noise tolerance level (0 to 100%).
AVERAGING-MODE is used to select the filter mode; either **MOVING** or **REPEAT**.
 - b. **MEDIAN** filter options:
DISABLE: Disables the median filter.
ENABLE: Enables the median filter and prompts you to enter the range (1 to 5).
4. Use the menu items to configure a filter. A menu item is selected by placing the cursor on it and pressing **ENTER**. Parameter values are changed using the cursor keys (◀ and ▶) and the **RANGE** (△ and ▽) keys, and then pressing **ENTER**.

Buffer (data store)

The Model 6517B has a buffer that can store from one to 15,706 readings. The actual number of readings that can be stored in the buffer depends on how many optional data elements are included for each reading (see Section 8 of the Reference Manual).

The basic data elements include the reading, units, reading number, and status (overflow or underflow). In addition to these items, recalled data also includes statistical information such as minimum, maximum, average, and standard deviation, which are part of the NEXT displays (see [Multiple displays](#) for more information).

Optional data elements include timestamp, humidity, external temperature, channel number (for scanning) and the V-Source level.

Storing readings

The following procedure to store readings uses a typical data store configuration: a user-defined number of readings will be stored in the buffer (fill-and-stop). All aspects of data store configuration and operation are detailed in Section 8 of the Reference Manual.

1. Set up the instrument for the desired measurements (function or range).
2. Configure the data store as follows. A menu item is selected by placing the cursor on it and pressing **ENTER**. Parameters are changed using the **RANGE** (△ and ▽) keys and pressing **ENTER** (see [Menus](#) for more information on navigating through the menu structure).
 - a. Press **CONFIG**.
 - b. Press **STORE**.
 - c. Select **CONTROL**.

- d. Select **FILL-AND-STOP**.
 - e. Select **ELEMENTS** (y = enable, n = disable).
 - f. Select **COUNT**.
 - g. Select **ENTER-COUNT** (enter buffer size).
 - h. If you enabled the **TIMESTAMP** data element, continue on to configure the timestamp. Otherwise, press **EXIT** to back out of the menu structure.
 - i. Select **TIMESTAMP**.
 - j. Select **TYPE**.
 - k. Select **REAL-TIME**.
 - l. Select **FORMAT**.
 - m. Select **ABSOLUTE**.
 - n. Use the **EXIT** key to back out of the menu structure.
3. Press **STORE**. The presently programmed buffer size (number of readings to store) is displayed. If desired, use the cursor keys (◀ and ▶) and the **RANGE** keys (△ and ▽) to change the buffer size (incrementing the most significant digit sets the buffer size to maximum).
 4. Press **ENTER** to start storing readings. The asterisk (*) annunciator turns on to indicate a data storage operation.
 5. To recall stored readings, press **RECALL**. Use the **RANGE** keys (△ and ▽) to scroll through the buffer.

Math

The MATH key lets you perform math operations on single readings and display the result. The six math calculations that are configured from the CONFIGURE MATH menu structure are:

Polynomial:

$$Y = (a2)X^2 + (a1)X + (a0)$$

Where: X is the normal display reading

a2, a1, and a0 are user-entered constants

Y is the displayed result

Percent:

$$Percent = \frac{Input\ Reading}{Target\ Value} \times 100$$

Where: Input Reading is the normal display reading

Target Value is a user-entered constant

Percent is the displayed result

Percent Deviation:

$$PD = \frac{(X - Y)}{Y} \times 100$$

Where: X is the normal display reading

Y is the user-entered reference value

PD is the displayed result (percent deviation)

Deviation:

$$Deviation = \frac{(X - Y)}{Y}$$

Where: X is the normal display reading
 Y is the user-entered reference value
 Deviation is the displayed result

Ratio:

$$Ratio = \frac{X}{Y}$$

Where: X is the normal display reading
 Y is the user-entered reference value
 Ratio is the displayed result

Log10 (logarithmic):

$$\log_{10} X = Y$$

Where: X is the input reading
 Y is the logarithmic result

Selecting and configuring math

The procedure to select and configure a math calculation is summarized as follows:

- Press **CONFIG** and then **MATH** to display the following math filter menu options:
 - NONE:** Selects no calculation when the MATH key is pressed.
 - POLYNOMIAL:** Selects the polynomial calculation and enters the constants (a2, a1, and a0).
 - PERCENT:** Selects the percent calculation and enters the target value (reference).
 - % DEV:** Selects the percent deviation calculation.
 - DEVIATION:** Selects the deviation calculation.
 - RATIO:** Selects the ratio calculation.
 - LOG10:** Selects the logarithmic calculation.
- Use the menu items to select and configure math. A menu item is selected by placing the cursor on it and pressing **ENTER**. Parameter values are changed using the cursor keys (◀ and ▶) and the **RANGE** keys (△ and ▽), and then pressing **ENTER**.

Enabling math

The selected math calculation is enabled by simply pressing the **MATH** key. When enabled, the MATH annunciator turns on and the calculation type (NONE, POLY, %, or % DEV) is displayed. Also, one of the following messages is briefly displayed:

Math Enabled
Display = NONE (reading)

Math Enabled
Display = POLY (reading)

Math Enabled
Display = % (reading)

Math Enabled
Display = % DEV (reading)

Math Enabled
Display = DEV (reading)

Math Enabled
Display = RATIO (reading)

Math Enabled
Display = LOG10 (reading)

Math is disabled by pressing **MATH** a second time.

Additional math operations

In addition to the math performed on single readings described above, the Model 6517B has these math operations:

- Math performed on buffered readings (maximum and minimum values, average, and standard deviation).
- Math performed on single readings as part of a pass/fail limits test.

Complete information on MATH is provided in Section 9 of the Reference Manual.

Figure 4-7
Combining math calculations

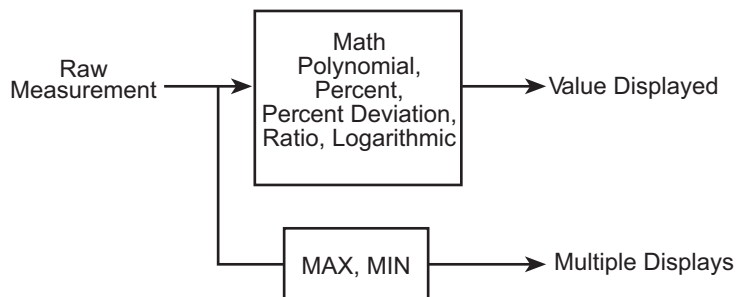

Test sequences

The following information summarizes the built-in test sequences of the Model 6517B. Detailed information on test sequences can be found in the Reference Manual.

Configuring test sequences

A test sequence is selected and configured from the CONFIGURE SEQUENCE menu as follows:

1. Press **CONFIG** and then **SEQ** to display the sequence configuration menu.
2. Place the cursor on **APPLICATIONS** and press **ENTER**. Select and configure a test from the test sequence menu structure. To select a menu item, place the cursor on it and press **ENTER**. To change a parameter value, use the cursor and **RANGE** keys (Δ and ∇), and press **ENTER**.

DEV-CHAR

Use to select a device characterization test:

- DIODE:** Diode leakage current test. Specify start voltage, stop voltage, step voltage, and delay.
- CAPACITOR:** Capacitor leakage current test. Specify bias voltage, bias time, and discharge time.
- CABLE:** Cable insulation resistance test. Specify bias voltage and bias time.
- RESISTOR:** Resistor voltage coefficient test. Specify source 1 voltage, delay 1, source 2 voltage, and delay 2.

RESISTIVITY

Use to select a resistivity test:

- SURFACE:** Surface resistivity test. Specify pre-discharge time, bias voltage, bias time, measure voltage, measure time, and discharge time.
- VOLUME:** Volume resistivity time. Specify pre-discharge time, bias voltage, bias time, measure voltage, measure time, and discharge time.

SIR

Surface insulation resistance test: Use to select the SIR test. Specify bias voltage, bias time, measure voltage, and measure time.

- SWEEP:** Use to select a sweep test:
- SQUARE-WAVE:** Square wave sweep test. Specify high-level voltage, time at high level, low-level voltage, time at low level, and cycle count.
- STAIRCASE:** Staircase sweep test. Specify start voltage, stop voltage, step voltage, and step time.

3. Press **EXIT** to display the following menu:

CONFIGURE SEQUENCE

Applications Control

4. Place the cursor on **CONTROL** and press **ENTER** to display the control sources that can be used to start the test. Place the cursor on the desired control source and press **ENTER**.

- MANUAL:** Pressing the TRIG key will start the test.
- IMMEDIATE:** Test will start immediately after it is armed.
- LID-CLOSURE:** Test will start when the lid of the Model 8009 test fixture is closed.
- GPIB:** Test will start when a bus trigger (*TRG or GET) is received by the Model 6517B.

- EXTERNAL:** Test will start when a trigger pulse (via EXT TRIG IN connector) is received by the Model 6517B.
- TRIGLINK:** Test will start when a trigger pulse (via TRIG LINK connector) is received by the Model 6517B. You will also be prompted to select the input line for the trigger.

Connections

WARNING *Hazardous voltages may be present on the output and guard terminals. To prevent electrical shock that could cause injury or death, NEVER make or break connections to the Model 6517B while the output is on. Power off the equipment from the front panel or disconnect the main power cord from the rear of the Model 6517B before handling cables connected to the outputs. Putting the equipment in standby mode does not guarantee that the outputs are not powered if a hardware or software fault occurs.*

Test sequences use the force voltage measure current (FVMI) technique as shown in [Figure 4-8](#). This connection scheme assumes that V-Source LO is internally connected to ammeter LO. This connection is controlled from the METER CONNECT option of the CONFIGURE V-SOURCE menu (see V-Source). Note that [Figure 4-8](#) does not meet the exact connection requirements for all the tests. It is only intended to show the general concept. More specific connection diagrams are provided in the Reference Manual.

Figure 4-8
Typical FVMI connections

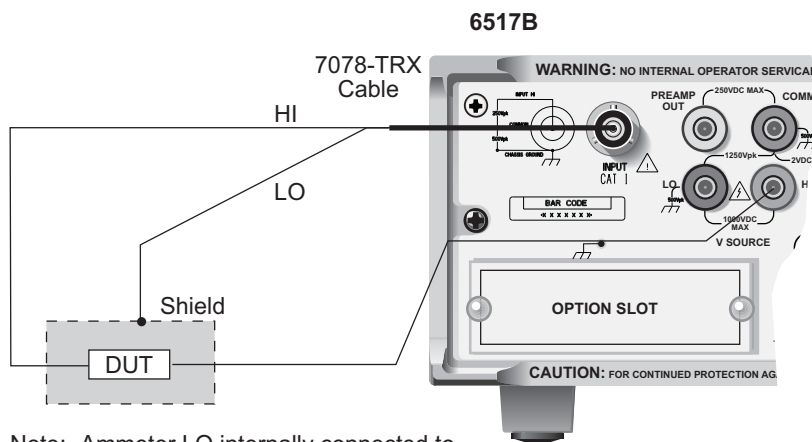

Note: Ammeter LO internally connected to V-source LO (see V-Source).

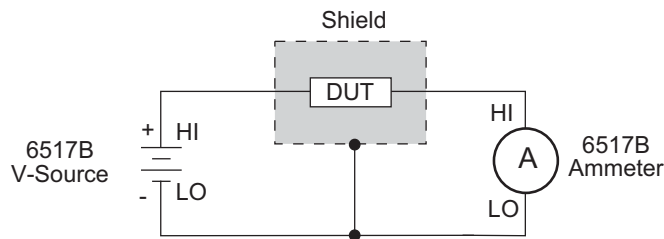

Running a test

After a test is selected, configured, and connected, perform the following steps to run the test:

1. Press the **SEQ** key. The display message will indicate the selected test.
2. Press **ENTER** to arm the test. The blinking "SEQ" message will be displayed. The test will start when the selected control source event occurs. Note that if the Immediate control source is selected, the test will start as soon as it is armed. After the test is armed, the TRIG key can be used to start the test regardless of which control source is selected.
3. When the test is finished, the "SEQ" display message is removed and the V-Source goes into standby.
4. Use the **RECALL** key to read the data from the buffer. Use the **RANGE** keys (Δ and ∇) to scroll through the data points.

Internal scanning

The Model 6517B can be used with a scanner card (such as the Keithley Instruments Model 6521 or Model 6522) installed in the option slot of the instrument. This section provides basic information for scanning internal channels. If the scanner card is not already installed, refer to the scanner card instruction manual.

For complete information on scanning (internal and external), refer to the scanner card instruction manuals. The scanner card must be installed in the option slot in order to access the menus to configure and run an internal scan.

Configure internal scanner

Perform the following steps to configure an internal scan:

1. Press **CONFIG** and then **CARD** to display the scanning options (internal or external).
2. Place the cursor on **INTERNAL** and press **ENTER** to display the menu items for the internal scanner.
3. Use the following menu structure to configure the internal scanner. To select a menu item, place the cursor on it and press **ENTER**. Parameter values are changed using the cursor keys (\blacktriangleleft and \blacktriangleright) and the **RANGE** keys (Δ and ∇).

CHANNELS: Selecting this menu item displays the status (on or off) for each channel. ON indicates that the channel will be included in the scan, while OFF indicates that the channel will not be included in the scan. To change the status of a channel(s), place the cursor on that channel and press a **RANGE** key (Δ and ∇). When finished, press **ENTER**.

SCAN-MODE: Use this menu item to set the scan mode. The VOLTAGE scan mode is faster and can be used when break-before-make switching is not required.

VSRC-LIMIT: Use this menu item to enable (YES) or disable (NO) the 200V V-Source limit. The $\pm 200V$ limit is used to protect the scanner card. Note that a V-Source limit (0 to $\pm 1000V$) may also be set from the Configure V-Source menu (see V-SOURCE).

SETTLING-TIME: Use this menu item to set a settling time (0 to 999.999 seconds) for each channel. Be sure to press **ENTER** after changing the time period.

4. Use the **EXIT** key to back out of the menu structure.

Perform the scan

Perform the following steps to scan internal channels. Note that menu items are selected by placing the cursor on it and pressing **ENTER**. Parameter values are changed using the cursor and **RANGE** keys and pressing **ENTER**.

1. Set up the Model 6517B for the desired measurement (for example, function, range, filter).
2. Press **CARD** to display the internal scanner options (close channel or perform scan).
3. Select **PERFORM-SCAN** to display the scan types (internal or external).
4. Select **INTERNAL** to display the scan count; the scan count indicates the number of times the scan will be repeated.
5. If desired, change the scan count and press **ENTER**.
6. You will then be asked if you wish to use the timer to provide a time interval between scans:
 - a. To use the timer, select **YES**. The present interval (in seconds) will be displayed. If desired, change the interval. Press **ENTER** to continue.
 - b. If you do not wish to use the timer, select **NO**.
7. You will then be asked if you wish to store the readings in the buffer:
 - a. To use the buffer, select **YES**. A message indicating the number of readings that will be stored in the buffer will be displayed. Press **ENTER** to continue.
 - b. If you do not wish to use the buffer, select **NO**.
8. With the message "Press ENTER to begin" displayed, press **ENTER** to start the scan.
9. After the scan is finished, the following options are available:
 - a. Recall data: If readings were stored in the buffer, select **RECALL-DATA** to display the stored readings. Use the **RANGE** keys (Δ and ∇) to scroll through the data points.
 - b. Scan again: If you wish to repeat the scan(s), select **SCAN-AGAIN**. Press **ENTER** to start the scan.
 - c. Exit: To return to the normal measurement mode, select **EXIT**. Note that stored readings can still be displayed by pressing the **RECALL** key.

Close/open channels

Perform the following steps to open or close a channel on an internal scanner card:

1. Press the **CARD** key to display the internal scanner options (close channel or perform scan).
2. Place the cursor on **CHANNEL-CLOSURES** and press **ENTER**.
3. The following channel closure options are available:
 - a. To close a channel, place the cursor on **CLOSE-CHANNEL** and press **ENTER**. Use the **RANGE** keys (Δ and ∇) to display the channel that you wish to close and press **ENTER**. The number of the closed channel will be displayed along with the reading.
 - b. To open all channels on the scanner card, place the cursor on **OPEN-ALL-CHANNELS** and press **ENTER**.

External scanning

The Model 6517B can be used with a scanner card installed in an external scanning mainframe (for example, the Keithley Instruments Model 7001 or 7002 Switch System). With the use of external triggering, the Model 6517B can measure and store each scanned channel.

For complete information on scanning (internal and external), refer to Section 10 of the Reference Manual, and the switch system and scanner card instruction manual.

The following steps assume that the Model 6517B is set to the **BENCH** reset default conditions and the Model 7001/7002 is set to the **RESET** default conditions (see [Restoring bench defaults](#) for more information).

Trigger connections

Connect the Model 6517B to the switch system as shown in [Figure 4-9](#). Detailed information on triggers is provided in Section 7 of the Reference Manual.

Figure 4-9
Trigger connections using trigger link

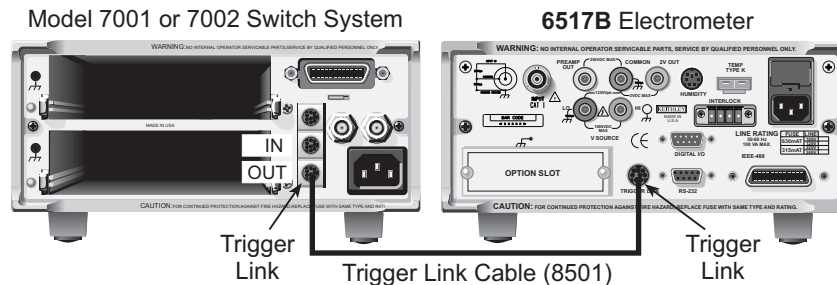

Configure external channels

The scanner configuration menu is used to specify the number of channels (external inputs) for the scan. If a scanner card is installed in the option slot of the Model 6517B, use procedure A. If the option slot is empty, use procedure B.

Procedure A

Scanner installed in option slot of Model 6517B:

1. Press **CONFIG** and then **CARD** to display the scanner configuration menu.
2. Place the cursor on **EXTERNAL** and press **ENTER**.
3. You will then be prompted to enter the number of external inputs (channels) for the scan. Use cursor keys (**◀** and **▶**) and the **RANGE** keys (**△** and **▽**) to change the number (1 to 400). Press **ENTER** to continue.
4. Press **EXIT** to return to the normal measurement display.

Procedure B

Option slot of Model 6517B empty:

1. Press **CONFIG** and then **CARD** to display the scanner configuration menu.
2. You will then be prompted to enter the number of external inputs (channels) for the scan. Use cursor keys (**◀** and **▶**) and the **RANGE** keys (**△** and **▽**) to change the number (1 to 400).
3. Press **ENTER** to return to the normal measurement display.

Perform the scan

Perform the following steps to scan external channels. Note that menu items are selected by placing the cursor on it and pressing **ENTER**. A parameter value is changed by using the **RANGE** keys (**△** and **▽**), and pressing **ENTER**.

1. On the Model 6517B, press the **CARD** key. If a scanner card is installed in the option slot of the Model 6517B, perform steps a and b. If the option slot is empty, proceed to step 2.
 - a. Place the cursor on **PERFORM-SCAN** and press **ENTER** to display the scan types (internal or external).
 - b. Place the cursor on **EXTERNAL** and press **ENTER**.
2. On the Switch System, if not already done, reset the Model 7001/2 as follows:
 - a. Press **MENU**.

- b. Select **SAVESETUP**.
 - c. Select **RESET**.
 - d. Select **ENTER**.
 - e. Select **ENTER**.
 - f. Use the **EXIT** key to back out of the menu structure.
3. On the Model 6517B, press **ENTER** to display the next message: "CONFIG EXT SCANNER; set CHAN COUNT to infinite."
4. On the Switch System, set the channel count to infinite as follows:
 - a. Press **SCAN**.
 - b. Select **SELECT-CONTROL > NUMBER-OF-CHANS > CHAN-COUNT > INFINITE**.
Note: Do not exit from the menu structure after selecting an infinite channel count.
5. On the Model 6517B, press **ENTER** to display the next message ("SELECT TRIG SOURCE"), and select the appropriate trigger source. If using the Trigger Link, select **TRIGLINK**. If you are instead using conventional external triggering, select **EXTERNAL**. The "CONFIG EXT SCANNER" message to set channel spacing for the Switch System will then be displayed.
6. On the Switch System, set channel spacing as follows. Note that the message on the Model 6517B tells you which channel spacing option to select:
 - a. Select **CHANNEL-SPACING**.
 - b. Select **TRIGLINK** or **EXTERNAL**.
 - c. Use the **EXIT** key to back out of the menu structure.
7. On the Model 6517B, press **ENTER**. The display will prompt you to define the scan list for the Switch System.
8. Use the Switch System to define the scan list.
9. On the Model 6517B, press **ENTER** to display "CONFIG EXT SCANNER; STEP scanner to first channel."
10. On the Switch System, press **STEP** to close the first channel in the scan.
11. On the Model 6517B, press **ENTER** to display the currently programmed scan count. The scan count specifies the number of scans to be performed. To change the scan count, use the cursor keys (◀ and ▶) and the **RANGE** keys (△ and ▽). Press **ENTER** to continue.
12. On the Model 6517B, you will be asked if you wish to use the scan timer. The timer is used to provide a time interval between each scan. If you select **YES**, enter the interval (in seconds).
13. You will then be asked if you wish to store the readings in the buffer. If you select **YES**, a message indicating the total number of readings to be stored in the buffer will be displayed. Press **ENTER** to continue.
14. With the message "Press ENTER to begin" displayed, press **ENTER** to start the scan process.
15. After the scan is completed, options to recall readings or repeat the scan will be displayed:
 - a. **RECALL-DATA**: Select this option to recall readings. Use the cursor keys and the range keys to scroll through the buffer. When finished, press **EXIT** to return to the post-scan options.—
 - b. **SCAN-AGAIN**: Use this option to repeat the scan.
 - c. **EXIT**: Use this option to disable the scan.

In this section:

Topic	Page
Overview	5-2
Software support	5-2
LabView driver	5-2
Remote interfaces	5-2
IEEE-488 bus	5-2
RS-232 interface	5-3
Common commands	5-5
SCPI commands	5-5
SCPI command syntax	5-6
SCPI signal-oriented commands	5-8
SCPI subsystem commands	5-8
Program examples	5-13
Changing function and range	5-13
One-shot triggering	5-14
Continuous triggering #1	5-15
Continuous triggering #2	5-15
Generating SRQ on buffer full	5-16
Storing readings in the buffer	5-17
Taking readings with the scanner card	5-18
Test sequence: Staircase sweep	5-19

Overview

For remote operation, the Keithley Instruments Model 6517B can use the IEEE-488 interface or the RS-232 interface. Common commands and Standard Commands for Programmable Instrumentation (SCPI) can be used with either interface.

For IEEE-488 operation, you can select the device dependent command (DDC) language mode. In this mode, you use DDCs instead of common commands and SCPI commands. This mode allows you to use the Model 6517B as an easy replacement for the Model 617 Electrometer. The 6517B can use existing programs written for the Model 617 without any code modifications. Appendix G of the Reference Manual lists the DDCs for the Model 6517B.

Software support

LabView driver

This driver allows you to use the Model 6517B with the National Instruments LabView package and is free upon request. Contact the Keithley Instruments applications group for details at 1-888-KEITHLEY (1-888-534-8453) within the U.S. and Canada.

Remote interfaces

IEEE-488 bus

Standards

For remote operation, the Model 6517B can use the IEEE-488 bus for communication between instrumentation and the controller (computer). The IEEE-488 bus is also known as the General Purpose Interface Bus (GPIB).

In addition to conforming to the IEEE-488-1978 and IEEE-488.1-1987 standards, the Model 6517B also conforms to the IEEE-488.2-1987 standard and the SCPI 1994 standard. These two standards allow most instrument operations to be performed with the use of common commands and SCPI commands.

IEEE-488 bus connections

The Model 6517B is connected to the IEEE-488 bus using a cable terminated with standard IEEE-488 connectors. [Figure 5-1](#) shows a typical connection scheme for a multi-unit test system. Note that connectors can be stacked to accommodate the parallel connection scheme.

To minimize interference caused by electromagnetic radiation, only use shielded IEEE-488 cables, such as the Keithley Instruments Model 7007-1 and Model 7007-2.

Figure 5-1
IEEE-488 connections

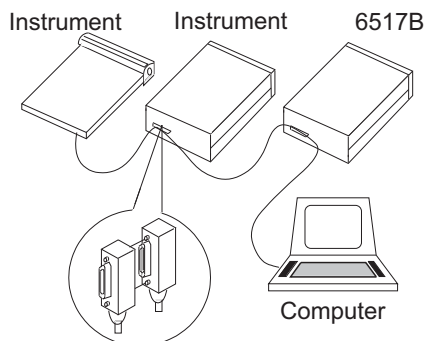

Address and language selection

The Model 6517B is shipped from the factory with the IEEE-488 bus selected, the primary address set to 27 and the SCPI language mode selected. The primary address is displayed on power up if the IEEE-488 bus is the selected interface.

Perform the following steps to select the IEEE-488 bus interface, check and change the primary address, and check and change the language mode:

1. Press **MENU** to display the MAIN MENU.
2. Place the cursor on **COMMUNICATION** and press **ENTER**. The interface options (GPIB and RS-232) are displayed.
3. Place the cursor on **GPIB** and press **ENTER** to select the IEEE-488 bus interface. If the RS-232 interface was previously selected, the unit will exit from the MAIN MENU when you select GPIB. In that event, repeat steps 1, 2, and 3 to continue in the menu structure.
4. Perform the following steps if you wish to check and change the primary address:
 - a. Place the cursor on **ADDRESSABLE** and press **ENTER** to display the addressable menu items (ADDRESS and LANGUAGE).
 - b. Place the cursor on **ADDRESS** and press **ENTER** to display the primary address.
 - c. To change the address, use the cursor keys (◀ and ▶) and the **RANGE** keys (△ and ▽) to display the desired address, then press **ENTER**. Each device on the bus must have a unique address. Typically, the computer uses address 0 or 21.
5. Perform the following steps if you wish to check and change the language mode:
 - a. Place the cursor on **LANGUAGE** and press **ENTER** to display the language options (SCPI or DDC). Cursor position indicates the present language mode.
 - b. Place the cursor on the desired language and press **ENTER**. Changing the language mode causes the unit to exit from the MAIN MENU. If you did not change the language, then use the **EXIT** key to back out of the menu structure.

RS-232 interface

RS-232 standard

For remote operation, the Model 6517B can use the RS-232 serial port for communication between instrumentation and the controller (computer). All commands, except DDCs, can be used over this serial port. The serial port is based on the electrical and mechanical characteristics of the RS-232-C standard.

RS-232 connections

The RS-232 serial port of the Model 6517B can be connected to the serial port of a computer using a standard, straight-through (not null modem) RS-232 cable terminated with DB-9 connectors. The serial port is located on the rear panel of the Model 6517B and is labeled "RS232."

If your computer uses a DB-25 connector for the RS-232 interface, you will need a cable or an adapter with a DB-25 connector on one end and a DB-9 connector on the other end. Again, make sure you use a straight through (not null modem) cable.

Interface selection and configuration

Perform steps below to select, check, and change the RS-232 interface settings for the Model 6517B. The RS-232 settings (baud rate, data bits, parity, and stop bits) of the Model 6517B must match the RS-232 settings of the communications package for your computer.

1. Press **MENU** to display the MAIN MENU.
2. Place the cursor on **COMMUNICATION** and press **ENTER**. The interface options (GPIB and RS-232) will then be displayed.
3. Place the cursor on **RS-232** and press **ENTER** to select the RS-232 interface. If the GPIB interface was previously selected, the unit will exit from the MAIN MENU when you select RS-232. In that event, repeat steps 1, 2, and 3 to continue in the menu structure.
4. Perform the following steps if you wish to check and change the baud rate:
 - a. Place the cursor on **BAUD** and press **ENTER** to display the available baud rates. Cursor position indicates the present baud rate setting. To retain the present baud rate setting, press **ENTER** or **EXIT**.
 - b. To change the baud rate, place the cursor on the desired setting and press **ENTER**.
5. Perform the following steps if you wish to check and change the number of data bits:
 - a. Place the cursor on **BITS** and press **ENTER** to display the available number of data bits (7 or 8). Cursor position indicates the present setting. To retain the present setting, press **ENTER** or **EXIT**.
 - b. To change the number of data bits, place the cursor on the alternate selection and press **ENTER**.
6. Perform the following steps if you wish to check and change parity:
 - a. Place the cursor on **PARITY** and press **ENTER** to display the parity options (NONE, ODD or EVEN). Cursor position indicates the present setting. To retain the present setting, press **ENTER** or **EXIT**.
 - b. To change parity, place the cursor on the desired selection and press **ENTER**.
7. Perform the following steps if you wish to check and change the number of stop bits:
 - a. Place the cursor on **STOP** and press **ENTER** to display the available number of stop bits (1 or 2). Cursor position indicates the present setting. To retain the present setting, press **ENTER** or **EXIT**.
 - b. To change the number of stop bits, place the cursor on the alternate selection and press **ENTER**.
8. Use the **EXIT** key to back out of the menu structure.

Common commands

Common commands are common to all IEEE-488 devices on the bus. The following information summarizes the common commands that are used most often. For complete details, refer to Section 11 of the Reference Manual.

***CLS** (clear status)

Clears all event registers and Error Queue. After clearing an event register, you can monitor the register for a bit to set, indicating that an event (such as the buffer becoming full) has occurred.

***RCL <Nrf>** (recall)

Returns the instrument to the instrument setup saved at the specified memory location. Example: To recall the setup saved at memory location 0, send `*RCL 0`.

***RST** (reset)

Returns the instrument to the `*RST` defaults and places the instrument in the idle state (ARM indicator off).

***SAV <Nrf>** (save)

Saves the instrument setup to the specified memory location (0 to 9). Example: To save the setup to memory location 0, send `*SAV 0`.

***TRG** (trigger)

When a trigger model control source is set for BUS, event detection is satisfied by sending this bus trigger. For example, if instrument operation is waiting at the measure (trigger) layer control source and it is programmed for BUS events, `*TRG` will provide the required event, resulting in a device action (measurement).

***WAI** (wait to continue)

This delay is used to allow the `*TRG` or an initiate command (`:INIT` or `:INIT:CONT ON`) to finish before processing any further commands. An `INITiate` command is not considered finished until instrument operation returns to the idle state.

SCPI commands

In the Model 6517B, you are given access to control settings that are hidden on other instruments. Because the instrument has more control points available, it requires more commands than its counterparts to perform comparable tasks. To accommodate this, the instrument incorporates the SCPI command set.

This introduction to the SCPI command set has three goals:

- Describe the syntax of SCPI commands. Included are descriptions of short forms and default nodes, which help reduce the amount of data sent to the instrument.
- Provide some simple programs to perform commonly used tasks.
- Describe the SCPI commands used in the example programs so you can modify the programs to suit your needs.

SCPI command syntax

Tree structure

SCPI commands are organized in a tree structure, similar to disk directories in computer operating systems. Each subdirectory is called a subsystem. For example, part of the `SENSe1` subsystem is listed below and shown in [Figure 5-2](#).

```
[SENSe[1]]
:DATA?
:FUNctIon <name>
:VOLtAge
[:DC]
:RANGe
[:UPPer] <n>
:AUTO <Boolean> | ONCE
:REFerence <n>
:STATe <Boolean>
:ACQuire
```

Figure 5-2
Hierarchy of the example `SENSe1` commands

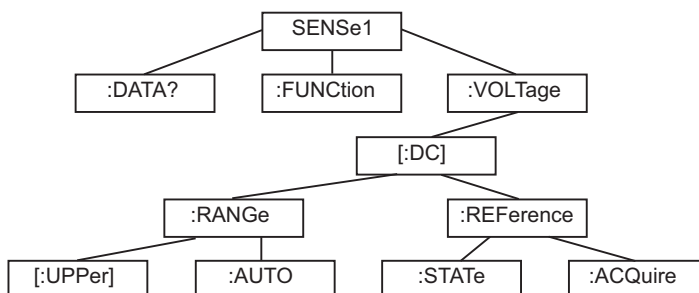

A command summary table is a way of documenting SCPI commands, but it does not show complete command names. A complete command is formed by joining the components. For example, the complete `:STATe` command in the example is:

```
SENSe1:VOLtAge[:DC]:REFerence:STATe
```

Note that square brackets are not part of the command; they indicate optional parts of the command.

This hierarchical approach permits the same command to be used many times. For example, many subsystems contain a `:STATe` command, but each one is unique because the complete command is unique. This is analogous to having a file named `INDEX.TXT`, for example, in each directory of your computer's hard disk. Although the files have the same name, they are unique because they are each in a different directory.

Long and short form commands

Every SCPI command has a short form, and most also have a long form. The notation used in documentation shows the short form in upper case, with the remainder of the name, which creates the long form, shown in lower case. There are no intermediate forms of the command name. You must send the exact short or long form. However, you do not have to use the mixed capitalization. The Model 6517B accepts commands in any combination of upper and lower case. For example, all of the following are valid forms of the `SENSe1:VOLtAge[:DC]:REFerence` command:

```
sense1:voltage[:dc]:reference:state
sens1:volt[:dc]:ref:stat
SENS1:volt[:DC]:rEFerENCE:StAt
```

Query commands

With few exceptions, every SCPI command has a corresponding query. A command sets a control point in the instrument; a query determines the present setting of the control point. The query is simply the command name with a question mark (?) attached.

Some commands are actions rather than control point settings. These commands have no query form. For example,

```
SENSe1:VOLTage[:DC]:REFerence:ACQuire
```

is an action command, not a setting, and so has no query form.

There are some queries that have no corresponding command. For example, `SENSe1:DATA?` causes the instrument to return the latest reading. Of course, there is no corresponding command to send a reading value to the instrument.

Default nodes

SCPI uses the concept of default nodes. Consider the example command tree shown previously in [Figure 5-2](#). What is within square brackets is not necessary to send to the instrument, but the instrument will accept it if you send it. Consider the `:UPPer` command, which sets the measurement range. To set the Model 6517B to measure 15VDC, any of the following commands works:

```
SENSe1:VOLTage[:DC]:RANGe:UPPer 15
SENSe:VOLTage[:DC]:RANGe:UPPer 15
SENSe1:VOLTage[:DC]:RANGe 15
VOLTage[:DC]:RANGe:UPPer 15
VOLTage[:DC]:RANGe 15
```

These are shown in long form, but short forms could also be used.

Command syntax

Notice in the preceding examples that there is no colon character at the beginning of the commands. A leading colon instructs the Model 6517B to interpret the command starting at the root (highest level) of the command tree. Since the Model 6517B also starts at the root each time you send it a new command, the leading colon is not needed (although the instrument will accept it if you send it).

You can send multiple commands in a single message. Separate the commands with a semicolon character. When the Model 6517B encounters a command following a semicolon, it attempts to interpret the command starting at the level of the previous command, unless you precede the second command with a colon. For example, either of the following command strings programs the Model 6517B to the 20V range and uses 5V as a relative value (with the `REFerence` commands):

```
volt[:dc]:rang 20;ref 5;ref:stat on
volt[:dc]:rang 20;:volt[:dc]:ref 5;:volt[:dc]:ref:stat on
```

The two command strings are treated identically by the Model 6517B. In the first string when the instrument encounters `;ref 5`, it notices the following:

- It is not the first command in the string
- There is no leading colon on the command
- The previous command was at the `VOLTage[:DC]` level

Therefore, it interprets the command as if it were at the `VOLTage[:DC]` level.

SCPI signal-oriented commands

Signal-oriented commands are used to acquire readings using a set of high-level instructions to control the measurement process. The two most commonly used commands are `:FETCh?` and `:MEASure?`.

Details on all signal-oriented commands are covered in Section 14 of the Reference Manual.

:FETCh?

This query command is used to request the latest post-processed reading. After sending this command and addressing the Model 6517B to talk, the reading will be sent to the computer. This command does not trigger a measurement, it simply requests the last available reading.

:MEASure[:<function>]?

In general, this command places the instrument in the “one-shot” measurement mode (ARM indicator off), triggers a single measurement, and then performs a `:FETCh?` command.

If you include the measurement function with this command, the instrument will first go to the specified function and then perform the one-shot measurement and query, as follows:

<code>:MEASure?</code>	Currently selected function
<code>:MEASure:VOLTage[:DC]?</code>	Volts function
<code>:MEASure:CURRent[:DC]?</code>	Amps function
<code>:MEASure:RESistance?</code>	Ohms function
<code>:MEASure:CHARge?</code>	Coulombs function

SCPI subsystem commands

Detailed information on all SCPI commands is covered in Section 14 of the Reference manual. In this section, only the commands used for basic operation are summarized.

Defaults

<code>:SYSTEM</code>	SYSTEM subsystem
<code>:PRESet</code>	Set the 6517B to the system preset defaults. Some of the selected defaults include: volts, continuous triggers, normal speed (1.0 PLC), and auto range.
<code>:POSetup <name></code>	Select power on setups: <code>RST</code> , <code>PRESet</code> , or <code>SAV0</code> through <code>SAV9</code> . Instrument will power up to the <code>*RST</code> or system present defaults, or one of the <code>*SAV0</code> – <code>*SAV9</code> setups.

Fresh readings

<code>[:SENSe[1]]</code>	SENSe subsystem
<code>:DATA:FRESH?</code>	Requests a new reading. This command will not request the same reading twice. If a new reading has already been triggered, this command will wait until the new reading is available.
<code>:CALCulate[1]</code>	CALCulate subsystem
<code>:DATA:FRESH?</code>	Requests a new calculated reading. When <code>CALC1</code> is enabled, <code>SENS:DATA:FRES?</code> is the reading before calculation and <code>CALC:DATA:FRES?</code> is the reading after calculation. When <code>CALC1</code> is disabled, the readings are the same.

Function configuration

<pre>[:SENSE [1]] :FUNCTION <name></pre>	<p>SENSE subsystem</p> <p>Select measurement function:</p> <pre><name>='VOLTage[:DC]' Volts function 'CURREnt[:DC]' Amps function 'RESistance' Ohms function 'CHARGE' Coulombs function</pre>
<pre>:VOLTage[:DC] :NPLC <n> :AUTO :RANGE [:UPPer] <n> :AUTO <n> :REFERENCE <n> :STATE :ACQuire :DIGits <n> :AUTO AVERage :TYPE <name> :TCONtrol <name> :COUNT <n> :ADVanced :NTOLerance <n> [:STATE] :MEDian :RANK <n> [:STATE] :GUARd </pre>	<p>Path to configure volts:</p> <p>Set speed: 0.01 to 10 PLC</p> <p>Enable or disable auto NPLC</p> <p>Path to configure measurement range:</p> <p>Specify expected reading to select range</p> <p>Enable or disable auto range</p> <p>Specify reference (rel): -210 to +210</p> <p>Enable or disable reference (rel)</p> <p>Use input signal as reference (rel)</p> <p>Specify measurement resolution</p> <p>Enable or disable auto resolution</p> <p>Path to control digital filter:</p> <p>Select filter (NONE, SCALAr or ADVanced)</p> <p>Select averaging method (REPEat, or MOVing)</p> <p>Specify filter count (1 to 100)</p> <p>Path to configure advanced filter:</p> <p>Specify noise tolerance (0 to 100%)</p> <p>Enable or disable digital filter</p> <p>Path to control median filter:</p> <p>Specify rank for filter (1 to 5)</p> <p>Enable or disable median filter</p> <p>Enable or disable guard</p>
<pre>:CURRENT:DC :DAMPing </pre>	<p>Path to configure Amps:</p> <p>(Volts commands)The same commands as Volts (except :GUARd) apply</p> <p>Enable or disable damping</p>
<pre>:RESistance [:AUTO] :RANGE [:UPPer] <n> :AUTO :MANual :CRANge [:UPPer] <n> :AUTO :VSource [:AMPLitude] <n> :RANGE <n> :OPERate :IREFERENCE :DAMPing :VSControl <name> :MSElect <name></pre>	<p>Path to configure Ohms:</p> <p>(Volts commands)The same commands as Volts (except :GUARd) apply</p> <p>Path to configure Auto V-Source Ohms:</p> <p>Path to set measurement range:</p> <p>Select range (0 to 100e18)</p> <p>Enable or disable auto range</p> <p>Path to configure Manual V-Source Ohms:</p> <p>Path to set measurement range:</p> <p>Select range (0 to 100e18)</p> <p>Enable or disable auto range</p> <p>Path to control the V-Source</p> <p>Specify V-Source level (0 to 1000)</p> <p>Set range; <100 = 100V range, >100 = 1000V range</p> <p>Enable or disable V-Source output</p> <p>Enable or disable amps reference</p> <p>Enable or disable damping</p> <p>Select ohms V-Source mode (MANual or AUTO)</p> <p>Select ohms type (NORMal or RESistivity)</p>

:RESistivity	Path to configure resistivity
:STHickness <Nrf>	Volume: Specify sample thickness; 0.0001 to 99.9999 (mm)
:FSElect <name>	Select test fixture (M8009 or USER)
:M8009	Path to query Model 8009 test fixture:
:RSwitch?	Query switch setting (SURFace or VOLume)
:USER	Path to configure user test fixture
:RSElect <name>	Select test type (SURFace or VOLume)
:KSURface <Nrf>	Surface: Specify Ks; 0.001 to 999.999
:KVOLume <Nrf>	Volume: Specify Kv; 0.001 to 999.999
:CHARge	Path to configure Coulombs: (Volts commands)The same commands as Volts (except :GUARd) apply
:ADIScharge	Path to control auto discharge
:LEVel <Nrf>	Set level (-2.2e6 to 2.2e6)
[:STATe] 	Enable or disable auto discharge

V-Source

:SOURce	SOURce subsystem
:VOLTage <n>	Specify V-Source level (0 to $\pm 1000V$)
:RANGe <n>	Select range; <100 = 100V range, >100 = 1000V range
:LIMit	Path for voltage limit:
[:AMPLitude] <n>	Specify voltage limit; 0 to 1000 (V)
:STATe 	Enable or disable limit
:MCONnect 	Enable or disable V-Source LO to ammeter LO connection
:CURRent	Path for current limit:
:RLIMit	Path to control resistive current limit:
:STATe 	Enable or disable resistive I-limit
:LIMit 	Path to check current compliance:
[:STATe]? 	Query state of current compliance

Data store (Buffer)

:TRACe	TRACe subsystem
:ELEMents <name>	Select reading elements :TSTamp, HUMidity, CHANnel, ETEMperature, VSource, NONE
:POINTs <n>	Specify buffer size
:FEED	Path to control buffer:
:CONTRol <name>	Select control mode and enable buffer: NEVer, NEXT, ALWays, Or PRETrigger
:DATA?	Read all readings in buffer

Open/close channels and scan

:ROUTe	ROUTe subsystem
:CLOSe <list>	Close specified channel
:STATe?	Query the closed channel
:OPEN <list>	Open specified channel
:OPEN:ALL	Open all channels
:SCAN	Path to control scanning:
[:INTernal] <list>	Specify internal scan list: 2 to 10 channels
:EXTernal <list>	Specify external scan list: 1 to 400 channels
:SMETHod <name>	Specify settling time for internal card; 0 to 99999.9999 (sec.)
:LSElect <name>	Enable the specified scan: INTernal, EXTernal or NONE

Trigger model

Performing a system preset (:SYSTEM:PRESet) configures the advanced trigger model for typical instrument operation. After a system preset, many advanced operations can be accomplished using the initiate commands, :ABORT, and the trigger (measure) layer commands.

:INITiate	
[:IMMEDIATE]	Take the instrument out of idle (ARM indicator on)
:CONTinuous 	Enable or disable continuous initiation
:ABORT	Reset trigger system; instrument stays in idle if continuous initiation is disabled (off)
:TRIGger	Path to configure the advanced trigger layer:
:SOURce <name>	Select control source: IMMEDIATE, TIMER, MANUAL, BUS, TLINK, EXTERNAL or HOLD
:TIMER <n>	Set timer interval (sec): 0.001 to 9999999.999
:DELAy <n>	Set delay between measurements (sec) 0 to 999999.999
:SYSTEM	
:MACRO	
:TRIGger	Path to configure basic triggering
[:EXECute]	Select basic triggering
:MODE <name>	Specify trigger mode (CONTinuous or ONEShot)
:SOURce <name>	Specify source (IMMEDIATE, MANUAL, BUS, EXTERNAL or TIMER)
:TIMER <n>	Specify timer interval; 0.001 to 99999.999 (sec.)

Test sequences

:TSEQUence	TSEQUence subsystem
:ARM	Arms selected test sequence
:ABORT	Stops a test sequence in process
:TYPE <name>	Specify test; DLEakage, CLEakage, CIResistance, RVCoefficient, SRESistivity, VRESistivity, SIREsistivity, SQSWEEP, STSWEEP
:TSource <name>	Specify trigger source; MANUAL, IMMEDIATE, BUS, TLINK, EXTERNAL, LClosure
:TLINE <NRf>	Specify TLINK line; 1 to 6
DLEakage	Diode leakage test path:
:START <NRf>	Specify start voltage; -1000 to 1000
:STOP <NRf>	Specify stop voltage; -1000 to 1000
:STEP <NRf>	Specify step voltage; -1000 to 1000
:MDELAy <NRf>	Specify measure delay; 0 to 99999.9s
CLEakage	Capacitor leakage test path:
:SVOLTage <NRf>	Specify bias voltage (-1000 to 1000)
:STIME <NRf>	Specify bias time; 0 to 99999.9s
:DTIME <NRf>	Specify discharge time; 0 to 9999.9s
CIResistance	Cable insulation resistance test path:
:SVOLTage <NRf>	Specify bias voltage; -1000 to 1000
:STIME <NRf>	Specify bias time; 0 to 99999.9s
RVCoefficient	Resistor voltage coefficient test path:
:SVOLTage [1] <NRf>	Specify source voltage 1; -1000 to 1000
:MDELAy [1] <NRf>	Specify measure delay 1; 0 to 99999.0s
:SVOLTage2 <NRf>	Specify source voltage 2; -1000 to 1000
:MDELAy2 <NRf>	Specify measure delay 2; 0 to 99999.9s
SRESistivity	Surface resistivity test path:

:PDTime <NRf>	Specify pre-discharge time; 0 to 99999.9s
:SVOLtage <NRf>	Specify bias voltage; -1000 to 1000
:STIME <NRf>	Specify bias time; 0 to 99999.9
:MVOLtage <NRf>	Specify measure voltage; -1000 to 1000
:MTIME <NRf>	Specify measure time; 0 to 99999.9s
:DTIME <NRf>	Specify discharge time; 0 to 99999.9s
:VRESistivity	Volume resistivity test path:
:PDTime <NRf>	Specify pre-discharge time; 0 to 99999.9s
:SVOLtage <NRf>	Specify bias voltage; -1000 to 1000
:STIME <NRf>	Specify bias time; 0 to 99999.9s
:MVOLtage <NRf>	Specify measure voltage; -1000 to 1000
:MTIME <NRf>	Specify measure time; 0 to 99999.9s
:DTIME <NRf>	Specify discharge time; 0 to 99999.9s
:SIResistance	Surface insulation resistance test path:
:SVOLtage <NRf>	Specify bias voltage; -1000 to 1000
:STIME <NRf>	Specify bias time; 0 to 99999.9s
:MVOLtage <NRf>	Specify measure voltage; -1000 to 1000
:MTIME <NRf>	Specify measure time; 0 to 99999.9s
:SQSweep	Square wave sweep test path:
:HLEVel <NRf>	Specify high-level voltage; -1000 to 1000
:HTIME <NRf>	Specify high-level time; 0 to 99999.9s
:LLEVel <NRf>	Specify low-level voltage; -1000 to 1000
:LTIME <NRf>	Specify low-level time; 0 to 99999.9s
:COUNT <NRf>	Specify number cycles
:STSWEEP	Staircase sweep test path:
:START <NRf>	Specify start voltage; -1000 to 1000
:STOP <NRf>	Specify stop voltage; -1000 to 1000
:STEP <NRf>	Specify step voltage; -1000 to 1000
:STIME <NRf>	Specify step time; 0 to 99999.9s

Status register

The status register structure of the Model 6517B lets you monitor and act upon numerous events that occur. Many programming decisions can be made by monitoring the measurement event register and the operation event register. See Section 14 of the User's Manual for details of the status registers.

:STATus	STATus subsystem
:MEASurement	Path for measurement status registers:
[:EVENT]?	Use to read the measurement event register
:OPERation	Path for operation status registers:
[:EVENT]?	Use to read the operation event register

When an event register is read, a decimal value is sent to the computer. The binary equivalent determines which bits in the register are set. For example, a decimal value of 33 indicates that bits B0 and B5 are set. An event register is cleared when it is read. Sending *CLS clears all event registers.

Some of the more useful bits of these event registers are summarized as follows:

Measurement event register	Operation event register
Bit B0 set = reading overflow	Bit B9 set = calculating
Bit B5 set = reading available	Bit B10 set = idle
Bit B7 set = buffer available	Bit B11 set = sequence test running
Bit B8 set = buffer half full	
Bit B9 set = buffer full	
Bit B14 set = V-source compliance	

Program examples

All examples presume QuickBASIC version 4.5 or higher and a Keithley Instruments KPC-488.2 or CEC IEEE-488 interface card with CEC driver version 2.11 or higher, with the Model 6517B at address 27 on the IEEE-488 bus.

Changing function and range

The Model 6517B has independent controls for each of its measurement functions. This means, for example, that autorange can be turned on for volts while leaving it off for amps.

Another difference is in the range command parameter. In older instruments, a single number was used to denote each range. The parameter of the SCPI `RANGE` command is given as "the maximum value to measure." The instrument interprets this parameter and goes to the appropriate range. When you query the range with `RANGE?` the instrument sends back the full-scale value of its present range.

The following example program illustrates changing function and range. It sets the range for several functions, then takes readings on each of those functions.

Note that the Model 6517B rounds the range parameter to an integer before choosing the appropriate range. Sending `VOLTage:DC:RANGE 20.45` will set the Model 6517B to the 20V range.

```
'Example program that demonstrates changing function and range,
'taking readings on various functions
'For QuickBASIC 4.5 and KPC-488.2/CEC interface card

'Edit the following line to where the QuickBASIC
'libraries are on your computer
'$INCLUDE: 'c:\qb45\ieeqb.bi'

'Initialize the interface as address 21
CALL initialize(21, 0)

'Reset the SENSE1 subsystem settings, along with the trigger
'model, each READ? will cause one trigger
CALL SEND(27, "*rst", status%)

'Set range for each function to measure
CALL SEND(27, "volt:dc:rang 10", status%)
CALL SEND(27, "curr:dc:rang 0.003", status%)
CALL SEND(27, "res:rang 10e6", status%)

'Switch to volts and take reading
CALL SEND(27, "func 'volt:dc';:read?", status%)
reading$ = SPACE$(80)
CALL ENTER(reading$, length%, 27, status%)
```

```

PRINT reading$

'Switch to current and take reading
CALL SEND(27, "func 'curr:dc';:read?", status%)
reading$ = SPACE$(80)
CALL ENTER(reading$, length%, 27, status%)
PRINT reading$

'Switch to 2-wire ohms and take reading
CALL SEND(27, "func 'res';:read?", status%)
reading$ = SPACE$(80)
CALL ENTER(reading$, length%, 27, status%)
PRINT reading$

```

One-shot triggering

Older instruments generally have two types of triggering: one-shot and continuous. In one-shot, each activation of the selected trigger source causes one reading. In continuous, the instrument is idle until the trigger source is activated, at which time it begins taking readings at a specified rate. Typical trigger sources for non-SCPI instruments are:

- IEEE-488 talk
- IEEE-488 Group Execute Trigger (GET)
- "X" command
- External trigger (rear panel BNC)

Arming the instrument to respond to triggers is implicit in the non-SCPI instruments. Simply sending a command to a non-SCPI instrument to change any of the trigger controls causes the instrument to arm itself for triggers.

The SCPI trigger model implemented in the Model 6517B gives you:

- Explicit control over the trigger source (the TRIGger subsystem)
- A two-level control for arming the instrument for triggers
- A way to completely disable triggers

Changing any of the settings in the TRIGger subsystem does not automatically arm the Model 6517B for triggers.

The following program sets up the Model 6517B to take one reading each time it receives an external trigger pulse.

```

'Example program that demonstrates one-shot external triggering
'For QuickBASIC 4.5 and KPC-488.2/CEC interface card.

'Edit the following line to where the QuickBASIC
'libraries are on your computer
'$INCLUDE: 'c:\qb45\ieeeqb.bi'

'Initialize the interface as address 21
CALL initialize(21, 0)

'Reset controls in INIT, ARM;LAY1, ARM:LAY2, and TRIG subsystems
'and put trigger model in IDLE state
CALL SEND(27, "*rst", status%)

CALL SEND(27, "trig:sour ext;coun inf", status%)

'start everything
CALL SEND(27, "init", status%)

```

After the Model 6517B receives the `INITiate` command, it stops in the `TRIGger` layer of the trigger model, waiting for a pulse on the external trigger jack. Each time a pulse arrives on the external trigger jack, the Model 6517B takes one reading. Because `TRIGger:COUNT` has been set to `INfinity`, the trigger model never exits from the `TRIGger` layer. You can send the `ABORT` command to put the trigger model in the idle state, disabling triggers until another `INITiate` command is sent.

Continuous triggering #1

The following example program sets up the Model 6517B to take readings as fast as it can once it receives an external trigger. The actual reading rate will depend upon other factors, such as A/D integration time, autorange on/off, and so on.

```
'Example program to demonstrate continuous triggering
'For QuickBASIC 4.5 and KPC-488.2/CEC interface card

'Edit the following line to where the QuickBASIC
'libraries are on your computer
'$INCLUDE: 'c:\qb45\ieeeqb.bi'

'Initialize the interface as address 21
CALL initialize(21, 0)

'Reset controls in INIT, ARM;LAY1, ARM:LAY2, and TRIG subsystems
'and put trigger model in IDLE state
CALL SEND(27, "*rst", status%)

'*RST sets TRIG:SOUR to IMM
CALL SEND(27, "arm:lay2:sour ext", status%)
CALL SEND(27, "trig:coun inf", status%)

'start everything
CALL SEND(27, "init", status%)
```

After the Model 6517B receives the `INITiate` command, it stops in `ARM:LAYer2` of the trigger model, waiting for a pulse on the external trigger jack. After the external trigger signal occurs, the Model 6517B moves to the `TRIGger` layer. Since `TRIGger:SOURce` is set to `IMMediate`, a reading is triggered immediately, with a subsequent reading triggered as soon as the previous one is finished.

Continuous triggering #2

The following example program sets up the Model 6517B to take readings continuously after an external trigger is received. The trigger rate is set to one reading every 50ms.

```
'Example program to demonstrate continuous triggering
'at a specified rate
'For QuickBASIC 4.5 and KPC-488.2/CEC interface card

'Edit the following line to where the QuickBASIC
'libraries are on your computer
'$INCLUDE: 'c:\qb45\ieeeqb.bi'

'Initialize the interface as address 21
CALL initialize(21, 0)

'Reset controls in INIT, ARM;LAY1, ARM:LAY2, and TRIG subsystems
'and put trigger model in IDLE state
CALL SEND(27, "*rst", status%)
```



```
*RST sets TRIG:SOUR to IMM
CALL SEND(27, "arm:lay2:sour ext", status%)
CALL SEND(27, "trig:coun inf;sour tim;tim .05", status%)

'start everything
CALL SEND(27, "init", status%)
```

After the Model 6517B receives the `INITiate` command, it stops in `ARM:LAYer2` of the trigger model, waiting for a pulse on the external trigger jack. After the external trigger signal occurs, the Model 6517B moves to the `TRIGger` layer. Since `TRIGger:SOURce` is set to `TIMer`, a reading is triggered immediately, with a subsequent reading every 50ms. Because `TRIGger:COUNT` has been set to infinity, the trigger model never exits from the `TRIGger` layer.

Generating SRQ on buffer full

When your program must wait until the Model 6517B has completed an operation, it is more efficient to program the Model 6517B to assert the IEEE-488 SRQ line when it is finished, rather than repeatedly serial polling the instrument. An IEEE-488 controller will typically address, then unaddress the instrument to talk each time it performs a serial poll. Repeated polling of the Model 6517B will generally reduce its overall reading throughput. Therefore, use the `srq%()` function call.

The Model 6517B provides a status bit for nearly every operation it performs. It can be programmed to assert the IEEE-488 SRQ line whenever a status bit becomes true or false. The IEEE-488 controller (your computer) can examine the state of the SRQ line without performing a serial poll, thereby detecting when the 6517B has completed its task without interrupting it in the process.

The following example program segment sets up the Model 6517B to assert SRQ when the reading buffer has completely filled, then arms the reading buffer, initiates readings, and waits for the Model 6517B to indicate that the buffer is full.

This is not a complete program. Not shown are the commands to configure the trigger model and the reading buffer (see the next example). The example shown here can be modified for any event in the Model 6517B status reporting system.

```
'Reset STATUS subsystem (not affected by *RST)
CALL SEND(27, "stat:pres;*cls", status%)

CALL SEND(27, "stat:meas:enab 512", status%)

'Enable BFL
CALL SEND(27, "*sre 1", status%)'enable MSB
CALL SEND(27, "trac:feed:cont next", status%)

'Start everything
CALL SEND(27, "init", status%)

WaitSRQ:
IF (NOT(srq%)) THEN GOTO WaitSRQ
CALL SPOLL(27, poll%, status%)
IF (poll% AND 64)=0 THEN GOTO WaitSRQ
```

Notice that after the program has detected an asserted SRQ line, it serial polls the Model 6517B to determine if it is the device requesting service. This is necessary for two reasons:

- Serial polling the Model 6517B causes it to quit asserting the SRQ line
- In test systems that have more than one IEEE-488 instrument programmed to assert SRQ, your program must determine which instrument is actually requesting service

Once an event register has caused a service request, it cannot cause another service request until you clear it by reading it (in this case using `STATUS:MEASurement[:EVENT]?`) or by sending the `*CLS` command.

Storing readings in the buffer

The reading buffer in the Model 6517B is flexible and capable. It has three controls, which are found in the `TRACe` subsystem. There are commands to control:

- The size of the buffer (in readings):

```
TRACe:POINts <Nrf>
```

- Whether or not extra data is stored with each reading (for example, channel number, time-stamp); storing extra data reduces the maximum size of the buffer:

```
TRACe:ELEMents <name>          Specify additional reading elements; TSTamp,
                                HUMidity, CHANnel, ETEMperature, VSOurce,
                                or NONE
```

- Select buffer control mode:

```
TRACe:FEED:CONTRol NEVER      Immediately stop storing readings
TRACe:FEED:CONTRol NEXT       Start now, stop when buffer is full
TRACe:FEED:CONTRol ALWays     Start now, never stop
TRACe:FEED:CONTRol PRETrigger Start now, stop when pretrigger is satisfied
```

The following example program sets up the Model 6517B to take 20 readings as fast as it can into the buffer, then reads the data back after the buffer has filled. The readings will be stored with the timestamp and other information, but the program reads back only the reading values and timestamp.

```
'Example program to demonstrate the reading buffer
'For QuickBASIC 4.5 and KPC-488.2/CEC interface card

'Edit the following line to where the QuickBASIC
'libraries are on your computer
'$INCLUDE: 'c:\qb45\ieeeqb.bi'

'Initialize the interface as address 21
CALL initialize(21, 0)

'Reset controls in INIT, ARM;LAY1, ARM:LAY2, and TRIG subsystems
'and put trigger model in IDLE state
CALL SEND(27, "*rst", status%)

'Reset STATUS subsystem (not affected by *RST)
CALL SEND(27, "stat:pres;*cls", status%)
CALL SEND(27, "stat:meas:enab 512", status%)'enable BFL
CALL SEND(27, "*sre 1", status%)'enable MSB
CALL SEND(27, "trig:coun 20", status%)

'TRACe subsystem is not affected by *RST
CALL SEND(27, "trac:poin 20;elem none", status%)
CALL SEND(27, "trac:feed:cont next", status%)

'Start everything
CALL SEND(27, "init", status%)

'Initialize reading$ while the 6517B is busy taking readings
reading$ = SPACE$(4000)

WaitSRQ:
```

```

IF (NOT(srq%) THEN GOTO WaitSRQ
CALL SPOLL(27, poll%, status%)
IF (poll% AND 64)=0 THEN GOTO WaitSRQ

CALL SEND(27, "trac:data?", status%)
CALL ENTER(reading$, length%, 27, status%)
PRINT reading$

```

Taking readings with the scanner card

The Model 6521 and Model 6522 are optional 10-channel scanner cards for the Model 6517B. Only one channel can be closed at a time. If you close a channel while another is already closed, the first one opens with break-before-make operation.

You can use the scanner card two ways. One is to issue a command to close a particular channel before sending other commands to take readings. The other way is to program the scan list, and let the meter take care of closing a channel before taking a reading.

The following example program measures voltage on channel 1, amps on channel 2, and resistance on channel 3, using the ROUTe:CLOSe command.

```

'Example program to demonstrate taking readings on different
'scanner channels
'For QuickBASIC 4.5 and KPC-488.2/CEC interface card

'Edit the following line to where the QuickBASIC
'libraries are on your computer
'$INCLUDE: 'c:\qb45\ieeeqb.bi'

'Initialize the interface as address 21
CALL initialize(21, 0)

'Reset controls in INIT, ARM;LAY1, ARM:LAY2, and TRIG subsystems
'and put trigger model in IDLE state, set function to volts
CALL SEND(27, "*rst", status%)

'Close channel 1, take voltage reading
CALL SEND(27, "rout:clos (@1);:read?", status%)
reading$ = SPACE$(80)
CALL ENTER(reading$, length%, 27, status%)
PRINT reading$

'Close channel 2, take current reading
CALL SEND(27, "func 'curr:dc'", status%)
CALL SEND(27, "rout:clos (@2);:read?", status%)
reading$ = SPACE$(80)
CALL ENTER(reading$, length%, 27, status%)
PRINT reading$

'Close channel 3, take ohms reading
CALL SEND(27, "func 'res'", status%)
CALL SEND(27, "rout:clos (@3);:read?", status%)
reading$ = SPACE$(80)
CALL ENTER(reading$, length%, 27, status%)
PRINT reading$

```

The following example program sets up the Model 6517B using a scan list to measure DC voltage on channels 1, 2, and 3. The meter takes ten sets of readings, with each set spaced 15 seconds apart, and each of the three readings in each group taken as fast as possible. The Model 6517B

stores the readings in the buffer, and asserts SRQ when the buffer is full. The program waits for the SRQ, then reads the readings from the buffer.

```
'Example program to demonstrate using the scan list
'For QuickBASIC 4.5 and KPC-488.2/CEC interface card

'Edit the following line to where the QuickBASIC
'libraries are on your computer
'$INCLUDE: 'c:\qb45\ieeeqb.bi'

'Initialize the interface as address 21
CALL initialize(21, 0)

'Reset controls in INIT, ARM;LAY1, ARM:LAY2, and TRIG subsystems
'and put trigger model in IDLE state, set function to DCV
CALL SEND(27, "*rst", status%)

'Reset STATUS subsystem (not affected by *RST)
CALL SEND(27, "stat:pres;*cls", status%)

CALL SEND(27, "stat:meas:enab 512", status%) 'enable BFL
CALL SEND(27, "*sre 1", status%) 'enable MSB

'*RST sets TRIG:SOUR to IMM
CALL SEND(27, "trig:coun 3", status%)
CALL SEND(27, "arm:lay2:sour tim;tim 15", status%)
CALL SEND(27, "arm:lay2:coun 10", status%)

'TRACe subsystem is not affected by *RST
CALL SEND(27, "trac:poin 30;elem none", status%)
CALL SEND(27, "trac:feed sens1;feed:coun next", status%)
' now the buffer is armed

CALL SEND(27, "rout:scan (@1:3)", status%)
CALL SEND(27, "rout:lssel init", status%)

'Start everything
CALL SEND(27, "init", status%)

'Initialize reading$ while the 6517B is busy taking readings
reading$ = SPACE$(2500)

WaitSRQ:
IF (NOT(srq%())) THEN GOTO WaitSRQ
CALL SPOLL(27, poll%, status%)
IF (poll% AND 64)=0 THEN GOTO WaitSRQ

CALL SEND(27, "form:elem read,time,chan", status%)
CALL SEND(27, "trac:data?", status%)
CALL ENTER(reading$, length%, 27, status%)
PRINT reading$
```

Test sequence: Staircase sweep

The following program performs a staircase sweep. Using the source voltage measure current (FVMI) method, this test will measure the current through a DUT at eleven voltage steps (0V through 10V) (see [Figure 4-3](#)). The eleven readings are stored in the buffer and displayed on the computer CRT at the conclusion of the test.

```
'Quick Basic 4.5, KPC-488.2/CEC card
```

```

'
'$INCLUDE: 'ieeeqb.bi'

CALL initialize(21, 0)
CLS
CALL send(27, "*rst", status%)
CALL send(27, "*CLS", status%)
CALL spoll(27, KIspoll%, status%)

'Configure status model to SRQ on Buffer Full:

CALL send(27, "stat:meas:enab 512", status%)
CALL SEND(27, "*sre 1", status%)

'Select autoranging amps:

CALL send(27, ":SENS:FUNC 'CURR'", status%)
CALL send(27, ":SENS:CURR:RANG:AUTO ON", status%)

'Configure Staircase Sweep from 0V to 10V in 1V steps:

CALL send(27, ":TSEQ:TYPE STSW", status%)
CALL send(27, ":TSEQ:STSW:STAR 0", status%)
CALL send(27, ":TSEQ:STSW:STOP 10", status%)
CALL send(27, ":TSEQ:STSW:STEP 1", status%)
CALL send(27, ":TSEQ:STSW:STIM 0.3", status%)
CALL send(27, ":TSEQ:TSO imm", status%)

'Wait for commands to complete processing:

DATA1$ = SPACE$(600)
CALL send(27, "*OPC?", status%)
CALL enter(DATA1$, length%, 27, status%)

' Start Test Sequence:

CALL send(27, ":TSEQ:ARM", status%)

'Wait for SRQ (buffer full):

WaitSRQ
IF (NOT (srq%)) THEN GOTO WaitSRQ
CALL spoll(27, poll%, status%)
If (poll% AND 64) = 0 THEN GOTO WaitSRQ

'Dump buffer readings to computer CRT:

CALL send(27, ":TRACE:DATA?", status%)
CALL enter(DATA1$, length%, 27, status%)
A = 1
FOR I = 1 TO 11
  r$ = MID$(DATA1$, A, 13)
  PRINT r$
  A = A + 14
NEXT I

END

```

A	Accessories 1-3	D	Data store (Buffer) 5-10
	Addenda, manual 1-3		Default nodes 5-7
	Additional math operations 4-18		Defaults 5-8
	Amps Rel 3-6		Bench 2-7
	Annunciators 2-2		Function settings 2-7
	Auto discharge 3-10		Restoring 2-7
	Auto V-source 3-6		Device action 4-12
B			Display 2-6
	Basic operation 4-9		Secondary 2-7
	Buffer (Data Store) 4-15		Display reading options 3-12
C		E	
	Cables and adapters 1-3		External scanning 4-22
	Capabilities 1-2	F	
	Changing function and range 5-13		Features 1-2
	Changing functions 3-2		Filter 4-13
	Charge measurements 3-9		Configuring 4-15
	Close/Open channels 4-22		Median 4-14
	Common commands 5-5		Modes 4-14
	Configure external channels 4-23		Types 4-14
	Configure internal scanner 4-21		Fresh readings 5-8
	Configure resolution 4-13		Front panel summary 2-2
	Configuring filters 4-15		Function configuration 5-9
	Configuring rel 4-10	G	
	Configuring speed 4-13		Generating SRQ on buffer full 5-16
	Configuring V-Source 4-9		Guarding 3-3
	Connections 3-10, 4-7, 4-20	H	
	Connectors		Handle 2-3
	2V Analog Output 2-5		Handling precautions 1-5
	Chassis Ground 2-5		Humidity measurements 3-10
	Common 2-5	I	
	Digital I/O 2-5		Idle 4-11
	Guard 2-5		IEEE-488 Bus
	Humidity 2-5		Address selection 5-3
	IEEE-488 2-5		IEEE-488 bus
	Input 2-4		Connections 5-2
	Interlock 2-5		Language selection 5-3
	Preamp Out 2-4		Standards 5-2
	RS-232 2-5		IEEE-488 bus standards 5-2
	Temp Type K 2-5		Inspection 1-5
	Trig Link 2-5		Instruction manual 1-5
	V-Source HI and LO 2-5		Internal scanning 4-21
	Continuous triggering #1 5-15	K	
	Continuous triggering #2 5-15		Keys
	Control sources 4-12		
	Counters 4-12		
	Current measurements 3-4		

- Display2-3
 - Function2-3
 - Operation2-3
 - Range2-3
 - Voltage source2-3
- L**
- LabView driver5-2
 - Line power connection2-6
 - Line voltage
 - Input module2-5
- M**
- Manual addenda1-3
 - Math4-16
 - Enabling4-18
 - Selecting and configuring4-17
 - Measurement control3-11
 - Median filter4-14
 - Menus4-5
 - Navigating4-6
 - Multiple displays4-3, 4-24
- N**
- Navigating menus4-6
- O**
- One-shot triggering5-14
 - Open/close channels and scan5-10
 - Option slot2-5
 - Options1-3, 1-5
 - Output trigger4-12
 - Overview5-2
- P**
- Perform the scan4-21, 4-23
 - Phone number1-2, 1-6
 - Power switch2-2
 - Power-up2-6
 - Probes1-4
 - Program examples5-13
- Q**
- Query commands5-7
- R**
- Rack mount kits1-4
 - Rear panel summary2-4
 - Relative4-9
 - Remote interfaces5-2
 - Repacking for shipment1-6
 - Resistance measurements3-4
 - Resistivity measurements3-7
 - Resolution4-13
 - RS-232 interface5-3
 - Configuration5-4
 - Connections5-4
 - Selection5-4
 - Standard5-3
 - Running a test4-21
- S**
- Safety symbols and terms1-5
 - Scanner cards1-4
 - SCPI commands5-5
 - Default nodes5-7
 - Long and short form5-6
 - Queries5-7
 - Syntax5-6, 5-7
 - Tree structure5-6
 - SCPI signal oriented commands5-8
 - SCPI subsystem commands5-8
 - Selecting and configuring a test sequence4-19
 - Service form1-6
 - Software1-4
 - Software support5-2
 - Speed4-13
 - Status register5-12
 - Storing readings4-15
 - Storing readings in buffer5-17
- T**
- Taking readings with the scanner card ..5-18
 - Temperature measurements3-10
 - Temperature units3-11
 - Test fixture1-4
 - Test Sequence — staircase sweep5-19
 - Test sequences4-19, 5-11
 - Trigger connections4-23
 - Trigger model5-11
 - Triggering4-10
 - Bench default setup4-12
 - Control sources4-12
 - Counters4-12
 - Device action4-12
 - Idle4-11
 - Output trigger4-12
- U**
- Unpacking1-5
- V**
- Voltage measurements3-2
 - Voltage source4-7
 - Basic operation4-9
 - Configuring4-9
 - Connections4-7
 - V-Source5-10
- Z**
- Zero check4-10
 - Zero correct4-10

Model No. _____ Serial No. _____ Date _____

Name and Telephone No. _____

Company _____

List all control settings, describe problem and check boxes that apply to problem. _____

Intermittent Analog output follows display Particular range or function bad; specify _____

IEEE failure Obvious problem on power-up Batteries and fuses are OK

Front panel operational All ranges or functions are bad Checked all cables

Display or output (check one)

- Drifts Unable to zero
 Unstable Will not read applied input
 Overload

Calibration only Certificate of calibration required

Data required

(attach any additional sheets as necessary)

Show a block diagram of your measurement system including all instruments connected (whether power is turned on or not). Also, describe signal source.

Where is the measurement being performed? (factory, controlled laboratory, out-of-doors, etc.)

What power line voltage is used? _____ Ambient temperature? °F _____

Relative humidity? _____ Other? _____

Any additional information. (If special modifications have been made by the user, please describe.)

Be sure to include your name and phone number on this service form.

Specifications are subject to change without notice.
All Keithley trademarks and trade names are the property of Keithley Instruments, Inc.
All other trademarks and trade names are the property of their respective companies.

KEITHLEY

A G R E A T E R M E A S U R E O F C O N F I D E N C E

Keithley Instruments, Inc.

Corporate Headquarters • 28775 Aurora Road • Cleveland, Ohio 44139 • 440-248-0400 • Fax: 440-248-6168 • 1-888-KEITHLEY • www.keithley.com